

Network UPS Tools User Manual

Russell Kroll, Arnaud Quette and Arjen de Korte

REVISION HISTORY

NUMBER	DATE	DESCRIPTION	NAME
2.8.0	2022-04-26	Current release of Network UPS Tools (NUT).	
2.6.0	2011-01-14	First release of AsciiDoc documentation for Network UPS Tools (NUT).	

Contents

1	Introduction	1
2	Network UPS Tools Overview	1
2.1	Description	1
2.2	Installing	1
2.3	Upgrading	1
2.4	Configuring and using	1
2.5	Documentation	2
2.6	Network Information	2
2.7	Manifest	2
2.8	Drivers	2
2.8.1	Extra Settings	3
2.8.2	Hardware Compatibility List	3
2.8.3	Generic Device Drivers	3
2.8.4	UPS Shutdowns	4
2.8.5	Power distribution unit management	4
2.9	Network Server	4
2.10	Monitoring client	5
2.10.1	Primary	5
2.10.2	Secondary	5
2.10.3	Additional Information	5
2.11	Clients	5
2.11.1	upsc	6
2.11.2	upslog	6
2.11.3	upsw	6
2.11.4	upscmd	7
2.12	CGI Programs	7
2.12.1	Access Restrictions	7
2.12.2	upsstats	7
2.12.3	upsimage	7
2.12.4	upsset	8
2.13	Version Numbering	8
2.14	Backwards and Forwards Compatibility	8
2.15	Support / Help / etc.	9
2.16	Hacking / Development Info	9
2.17	Acknowledgements / Contributions	9

3	Features	9
3.1	Multiple manufacturer and device support	9
3.2	Multiple architecture support	9
3.3	Layered and modular design with multiple processes	10
3.4	Redundancy support — Hot swap/high availability power supplies	10
3.5	Security and access control	10
3.6	Web-based monitoring	10
3.7	Free software	10
3.8	UPS management and control	11
3.9	Monitoring diagrams	11
3.9.1	"Simple" configuration	11
3.9.2	"Advanced" configuration	12
3.9.3	"Big Box" configuration	12
3.9.4	"Bizarre" configuration	13
3.10	Image credits	13
3.11	Compatibility information	13
3.11.1	Hardware	13
3.11.2	Operating systems	13
4	Download information	14
4.1	Source code	14
4.1.1	Stable tree: 2.8	14
4.1.2	Development tree:	14
	Code repository	14
	Browse code	15
	Snapshots	15
4.1.3	Older versions	15
4.2	Binary packages	15
4.3	Java packages	16
4.4	Virtualization packages	16
4.4.1	VMware	16
5	Installation instructions	16
5.1	Installing from source	16
5.1.1	Prepare your system	17
	System User creation	17
5.1.2	Build and install	17
	Configuration	17
	Build the programs	17

Installation	18
State path creation	18
Ownership and permissions	18
5.2 Installing from packages	19
5.2.1 Debian, Ubuntu and other derivatives	19
5.2.2 Mandriva	19
5.2.3 SUSE / openSUSE	19
5.2.4 Red Hat, Fedora and CentOS	20
5.2.5 FreeBSD	20
Binary package	20
Port	20
USB UPS on FreeBSD	21
6 Configuration notes	21
6.1 Details about the configuration files	21
6.1.1 Generalities	21
6.1.2 Line spanning	22
6.2 Basic configuration	23
6.2.1 Driver configuration	23
6.2.2 Starting the driver(s)	24
6.2.3 Driver(s) as a service	24
6.2.4 Data server configuration (upsd)	25
6.2.5 Starting the data server	25
6.2.6 Check the UPS data	26
Status data	26
All data	26
6.2.7 Startup scripts	27
6.3 Configuring automatic shutdowns for low battery events	27
6.3.1 Shutdown design	27
6.3.2 How you set it up	29
NUT user creation	29
Reloading the data server	29
Power Off flag file	29
Securing upsmon.conf	29
Create a MONITOR directive for upsmon	30
Define a SHUTDOWNCMD for upsmon	30
Start upsmon	30
Checking upsmon	30
Startup scripts	31

Shutdown scripts	31
Testing shutdowns	32
6.3.3 Using suspend to disk	32
6.3.4 RAID warning	32
6.4 Typical setups for enterprise networks and data rooms	33
6.5 Typical setups for big servers with UPS redundancy	34
6.5.1 Example configuration	34
6.5.2 Multiple UPS shutdowns ordering	35
6.5.3 Other redundancy configurations	36
7 Advanced usage and scheduling notes	36
7.1 The simple approach, using your own script	36
7.1.1 How it works relative to upsmon	36
7.1.2 Setting up everything	36
7.1.3 Using more advanced features	37
7.1.4 Suppressing notify storms	37
7.2 The advanced approach, using upssched	37
7.2.1 How upssched works relative to upsmon	37
7.2.2 Setting up your upssched.conf	38
The big picture	38
Establishing timers	38
Executing commands immediately	38
7.2.3 Writing the command script handler	39
7.2.4 Early Shutdowns	39
7.2.5 Background	40
8 NUT outlets management and PDU notes	40
8.1 Introduction	40
8.2 NUT outlet data collection	40
8.3 Outlets on PDU	41
8.4 Outlets on UPS	41
8.5 Other type of devices	41
9 NUT daisychain support notes	41
9.1 Introduction	42
9.2 Implementation notes	42
9.2.1 General specification	42
Devices status handling	42
Devices alarms handling	42
Example	43
9.2.2 Information for developers	43
Base support	43
Templates with multiple definitions	44
Devices alarms handling	44

10 Notes on securing NUT	45
10.1 How to verify the NUT source code signature	45
10.2 System level privileges and ownership	46
10.3 NUT level user privileges	46
10.4 Network access control	46
10.4.1 NUT LISTEN directive	47
10.4.2 Firewall	47
Uncomplicated Firewall (UFW) support	47
10.4.3 TCP Wrappers	48
10.5 Configuring SSL	48
10.5.1 OpenSSL backend usage	48
Install OpenSSL	48
Recompile and install NUT	48
Create a certificate and key for upsd	48
Figure out the hash for the key	49
Install the client-side certificate	49
Create the combined file for upsd	49
Note on certification authorities (CAs) and signed keys	49
Install the server-side certificate	50
Clean up the temporary files	50
Restart upsd	50
Point upsmon at the certificates	50
Recommended: make upsmon verify all connections with certificates	50
Recommended: force upsmon to use SSL	50
10.5.2 NSS backend usage	51
Install NSS	51
Recompile and install NUT	51
Create certificate and key for the host	51
Create a self-signed CA certificate	51
Install the server-side certificate	52
upsd (required): certificate database and self certificate	52
upsd (optional): client authentication	52
upsmon (required): upsd authentication	52
upsmon (optional): certificate database and self certificate	53
10.5.3 Restart upsd	53
10.5.4 Restart upsmon	53
10.5.5 Recommended: sniff the connection to see it for yourself	53
10.5.6 Potential problems	53
10.5.7 Conclusion	54

10.6 chrooting and other forms of paranoia	54
10.6.1 Generalities	54
10.6.2 symlinks	55
10.6.3 upsmon	55
10.6.4 Config files	55
A Glossary	56
B Acknowledgements / Contributions	56
B.1 The NUT Team	56
B.1.1 Active members	56
B.1.2 Retired members	57
B.2 Supporting manufacturers	57
B.2.1 UPS manufacturers	57
B.2.2 Appliances manufacturers	58
B.3 Other contributors	58
B.4 Older entries (before 2005)	59
C NUT command and variable naming scheme	59
C.1 Time and Date format	60
C.2 Variables	60
C.2.1 device: General unit information	60
C.2.2 ups: General unit information	60
C.2.3 input: Incoming line/power information	62
C.2.4 output: Outgoing power/inverter information	63
C.2.5 Three-phase additions	63
Phase Count Determination	63
DOMAINs	63
Specification (SPEC)	64
CONTEXT	64
Valid CONTEXTs	64
Valid SPECs	64
C.2.6 EXAMPLES	65
C.2.7 battery: Any battery details	65
C.2.8 ambient: Conditions from external probe equipment	67
C.2.9 outlet: Smart outlet management	68
outlet.group: groups of smart outlets	69
C.2.10 driver: Internal driver information	70
C.2.11 server: Internal server information	70
C.3 Instant commands	70

D	Hardware Compatibility List	71
E	Documentation	71
E.1	User Documentation	71
E.2	Developer Documentation	71
E.3	Data dumps for the DDL	72
E.4	Offsite Links	72
E.5	News articles and Press releases	73
F	Support instructions	73
F.1	Documentation	73
F.2	Mailing lists	73
F.2.1	Request help	73
F.2.2	Post a patch, ask a development question, ...	74
F.2.3	Discuss packaging and related topics	74
F.3	IRC (Internet Relay Chat)	74
F.4	GitHub Issues	74
G	Cables information	74
G.1	APC	74
G.1.1	940-0024C clone	74
G.1.2	940-0024E clone	75
G.1.3	940-0024C clone for Macs	75
G.2	Belkin	75
G.2.1	OmniGuard F6C***-RKM	75
G.3	Eaton	76
G.3.1	MGE Office Protection Systems	76
	DB9-DB9 cable (ref 66049)	76
	DB9-RJ45 cable	77
	NMC DB9-RJ45 cable	78
	USB-RJ45 cable	78
	DB9-RJ12 cable	79
G.3.2	Powerware LanSafe	81
G.3.3	SOLA-330	81
G.4	HP - Compaq	82
G.4.1	Older Compaq UPS Family	82
G.5	Phoenixtec (Best Power)	82
G.6	Tripp-Lite	83

H	Configure options	83
H.1	Driver selection	84
H.1.1	Serial drivers	84
H.1.2	USB drivers	84
H.1.3	SNMP drivers	84
H.1.4	XML drivers and features	84
H.1.5	LLNC CHAOS Powerman driver	84
H.1.6	IPMI drivers	85
H.1.7	I2C bus drivers	85
H.1.8	Modbus drivers	85
H.1.9	Manual selection of drivers	85
H.2	Optional features	85
H.2.1	CGI client interface	85
H.2.2	Pretty documentation and man pages	86
H.2.3	Development files	86
H.2.4	Options for developers	87
H.2.5	I want it all!	87
H.2.6	Networking transport security	87
H.2.7	Networking access security	87
H.2.8	Networking IPv6	87
H.2.9	AVAHI/mDNS	88
H.2.10	LibLTDL	88
H.3	Other configuration options	88
H.3.1	NUT data server port	88
H.3.2	Daemon user accounts	88
H.3.3	Syslog facility	89
H.4	Installation directories	89
H.5	Directories used by NUT at run-time	91
H.6	Things the compiler might need to find	91
H.6.1	LibGD	91
H.6.2	LibUSB	92
H.6.3	Various	92
I	Upgrading notes	92
I.1	Changes from 2.7.4 to 2.8.0	92
I.2	Changes from 2.7.3 to 2.7.4	94
I.3	Changes from 2.7.2 to 2.7.3	94
I.4	Changes from 2.7.1 to 2.7.2	94
I.5	Changes from 2.6.5 to 2.7.1	95

I.6	Changes from 2.6.4 to 2.6.5	95
I.7	Changes from 2.6.3 to 2.6.4	95
I.8	Changes from 2.6.2 to 2.6.3	95
I.9	Changes from 2.6.1 to 2.6.2	95
I.10	Changes from 2.6.0 to 2.6.1	95
I.11	Changes from 2.4.3 to 2.6.0	95
I.12	Changes from 2.4.2 to 2.4.3	95
I.13	Changes from 2.4.1 to 2.4.2	96
I.14	Changes from 2.4.0 to 2.4.1	96
I.15	Changes from 2.2.2 to 2.4.0	96
I.16	Changes from 2.2.1 to 2.2.2	96
I.17	Changes from 2.2.0 to 2.2.1	96
I.18	Changes from 2.0.5 to 2.2.0	96
I.19	Changes from 2.0.4 to 2.0.5	97
I.20	Changes from 2.0.3 to 2.0.4	97
I.21	Changes from 2.0.2 to 2.0.3	97
I.22	Changes from 2.0.1 to 2.0.2	97
I.23	Changes from 2.0.0 to 2.0.1	97
I.24	Changes from 1.4.0 to 2.0.0	97
J	Project history	98
J.1	Prototypes and experiments	98
J.1.1	May 1996: early status hacks	98
J.1.2	January 1997: initial protocol tests	99
J.1.3	September 1997: first client/server code	99
J.2	Smart UPS Tools	100
J.2.1	March 1998: first public release	100
J.2.2	June 1999: Redesigned, rewritten	100
J.3	Network UPS Tools	100
J.3.1	September 1999: new name, new URL	100
J.3.2	June 2001: common driver core	101
J.3.3	May 2002: casting off old drivers, IANA port, towards 1.0	101
J.4	Leaving 0.x territory	101
J.4.1	August 2002: first stable tree: NUT 1.0.0	101
J.4.2	November 2002: second stable tree: NUT 1.2.0	101
J.4.3	April 2003: new naming scheme, better driver glue, and an overhauled protocol	102
J.4.4	July 2003: third stable tree: NUT 1.4.0	102
J.4.5	July 2003: pushing towards 2.0	102
J.5	networkupstools.org	103

J.5.1	November 2003: a new URL	103
J.6	Second major version	103
J.6.1	March 2004: NUT 2.0.0	103
J.7	The change of leadership	103
J.7.1	February 2005: NUT 2.0.1	103
K	Prerequisites for building NUT on different OSes	103
K.1	General call to Test the ability to configure and build	104
K.2	Build prerequisites to make NUT from scratch on various Operating Systems	105
K.2.1	Debian 10/11	105
K.2.2	CentOS 7	106
K.2.3	FreeBSD 12.2	108
K.2.4	OpenBSD 6.4	110
K.2.5	NetBSD 9.2	112
K.2.6	OpenIndiana 2021.10	113
K.2.7	OmniOS CE (as of release 151036)	115
L	CI Farm configuration notes	116
L.1	Setting up the multi-arch Linux LXC container farm for NUT CI	116
L.1.1	Common preparations	117
L.1.2	Setup a container	117
L.1.3	Shepherd the herd	119
L.1.4	Further setup of the containers	121
L.1.5	Troubleshooting	121
L.2	Connecting Jenkins to the containers	122
L.2.1	Agent Labels	122
Labels for QEMU	122	
Labels for native builds	123	
L.2.2	Generic agent attributes	123
L.2.3	Where to run agent.jar	123
Using Jenkins SSH Build Agents	124	
Using Jenkins Swarm Agents	125	
L.2.4	Sequentializing the stress	125
Running one agent at a time	125	
Sequentializing the git cache access	125	

1 Introduction

Two NUT websites

This version of the page reflects NUT release *v2.8.0* with codebase committed ff16dabca at 2022-04-04T11:04:28+00:00. Options, features and capabilities in current development (and future releases) are detailed on the main site and may differ from ones described here.

The primary goal of the Network UPS Tools (NUT) project is to provide support for Power Devices, such as Uninterruptible Power Supplies, Power Distribution Units and Solar Controllers.

NUT provides many control and monitoring [features](#), with a uniform control and management interface.

More than 140 different manufacturers, and several thousands of models are [compatible](#).

This software is the combined effort of many [individuals and companies](#).

This document intend to describe how to install software support for your [Power Devices](#) (UPS, PDU, . . .), and how to use the NUT project. It is not intended to explain what are, nor distinguish the different technologies that exist. For such information, have a look at the [General Power Devices Information](#).

If you wish to discover how everything came together, have a look at the [Project History](#).

2 Network UPS Tools Overview

2.1 Description

Network UPS Tools is a collection of programs which provide a common interface for monitoring and administering UPS, PDU and SCD hardware. It uses a layered approach to connect all of the parts.

Drivers are provided for a wide assortment of equipment. They understand the specific language of each device and map it back to a compatibility layer. This means both an expensive high end UPS, a simple "power strip" PDU, or any other power device can be handled transparently with a uniform management interface.

This information is cached by the network server `upsd`, which then answers queries from the clients. `upsd` contains a number of access control features to limit the abilities of the clients. Only authorized hosts may monitor or control your hardware if you wish. Since the notion of monitoring over the network is built into the software, you can hang many systems off one large UPS, and they will all shut down together. You can also use NUT to power on, off or cycle your data center nodes, individually or globally through PDU outlets.

Clients such as `upsmem` check on the status of the hardware and do things when necessary. The most important task is shutting down the operating system cleanly before the UPS runs out of power. Other programs are also provided to log information regularly, monitor status through your web browser, and more.

2.2 Installing

If you are installing these programs for the first time, go read the [installation instructions](#) to find out how to do that. This document contains more information on what all of this stuff does.

2.3 Upgrading

When upgrading from an older version, always check the [upgrading notes](#) to see what may have changed. Compatibility issues and other changes will be listed there to ease the process.

2.4 Configuring and using

Once NUT is installed, refer to the [configuration notes](#) for directions.

2.5 Documentation

This is just an overview of the software. You should read the man pages, included example configuration files, and auxiliary documentation for the parts that you intend to use.

2.6 Network Information

These programs are designed to share information over the network. In the examples below, `localhost` is used as the host-name. This can also be an IP address or a fully qualified domain name. You can specify a port number if your `upsd` process runs on another port.

In the case of the program `upsc`, to view the variables on the UPS called `sparky` on the `upsd` server running on the local machine, you'd do this:

```
/usr/local/ups/bin/upsc sparky@localhost
```

The default port number is 3493. You can change this with "configure --with-port" at compile-time. To make a client talk to `upsd` on a specific port, add it after the hostname with a colon, like this:

```
/usr/local/ups/bin/upsc sparky@localhost:1234
```

This is handy when you have a mixed environment and some of the systems are on different ports.

The general form for UPS identifiers is this:

```
<upsname>[@<hostname>[:<port>]]
```

Keep this in mind when viewing the examples below.

2.7 Manifest

This package is broken down into several categories:

- **drivers** - These programs talk directly to your UPS hardware.
- **server** - `upsd` serves data from the drivers to the network.
- **clients** - They talk to `upsd` and do things with the status data.
- **cgi-bin** - Special class of clients that you can use with your web server.
- **scripts** - Contains various scripts, like the Perl and Python binding, integration bits and applications.

2.8 Drivers

These programs provide support for specific UPS models. They understand the protocols and port specifications which define status information and convert it to a form that `upsd` can understand.

To configure drivers, edit `ups.conf`. For this example, we'll have a UPS called "sparky" that uses the `apcsmart` driver and is connected to `/dev/ttyS1`. That's the second serial port on most Linux-based systems. The entry in `ups.conf` looks like this:

```
[sparky]
    driver = apcsmart
    port = /dev/ttyS1
```

To start and stop drivers, use `upsdrcctl` or `upsdrcsvctl` (installed on operating systems with a service management framework supported by NUT). By default, it will start or stop every UPS in the config file:

```
/usr/local/ups/sbin/upsdrvctl start
/usr/local/ups/sbin/upsdrvctl stop
```

However, you can also just start or stop one by adding its name:

```
/usr/local/ups/sbin/upsdrvctl start sparky
/usr/local/ups/sbin/upsdrvctl stop sparky
```

On operating systems with a supported service management framework, you might wrap your NUT drivers into individual services instances with:

```
/usr/local/ups/sbin/upsdrvsvccctl resync
```

and then manage those service instances with commands like:

```
/usr/local/ups/sbin/upsdrvsvccctl start sparky
/usr/local/ups/sbin/upsdrvsvccctl stop sparky
```

To find the driver name for your device, refer to the section below called "HARDWARE SUPPORT TABLE".

2.8.1 Extra Settings

Some drivers may require additional settings to properly communicate with your hardware. If it doesn't detect your UPS by default, check the driver's man page or help (-h) to see which options are available.

For example, the `usbhid-ups` driver allows you to use USB serial numbers to distinguish between units via the "serial" configuration option. To use this feature, just add another line to your `ups.conf` section for that UPS:

```
[sparky]
    driver = usbhid-ups
    port = auto
    serial = 1234567890
```

2.8.2 Hardware Compatibility List

The [Hardware Compatibility List](#) is available in the source directory (`nut-X.Y.Z/data/driver.list`), and is generally distributed with packages. For example, it is available on Debian systems as:

```
/usr/share/nut/driver.list
```

This table is also available [online](#).

If your driver has vanished, see the [FAQ](#) and [Upgrading notes](#).

2.8.3 Generic Device Drivers

NUT provides several generic drivers that support a variety of very similar models.

- The `genericups` driver supports many serial models that use the same basic principle to communicate with the computer. This is known as "contact closure", and basically involves raising or lowering signals to indicate power status. This type of UPS tends to be cheaper, and only provides the very simplest data about power and battery status. Advanced features like battery charge readings and such require a "smart" UPS and a driver which supports it. See the [genericups\(8\)](#) man page for more information.

- The `usbhid-ups` driver attempts to communicate with USB HID Power Device Class (PDC) UPSes. These units generally implement the same basic protocol, with minor variations in the exact set of supported attributes. This driver also applies several correction factors when the UPS firmware reports values with incorrect scale factors.
See the [usbhid-ups\(8\)](#) man page for more information.
- The `blazer_ser` and `blazer_usb` drivers supports the Megatec / Q1 protocol that is used in many brands (Blazer, Energy Sistem, Fenton Technologies, Mustek and many others).
See the [blazer\(8\)](#) man page for more information.
- The `snmp-ups` driver handles various SNMP enabled devices, from many different manufacturers. In SNMP terms, `snmp-ups` is a manager, that monitors SNMP agents.
See the [snmp-ups\(8\)](#) man page for more information.
- The `powerman-pdu` is a bridge to the PowerMan daemon, thus handling all PowerMan supported devices. The PowerMan project supports several serial and networked PDU, along with Blade and IPMI enabled servers.
See the [powerman-pdu\(8\)](#) man page for more information.
- The `apcupsd-ups` driver is a bridge to the Apcupsd daemon, thus handling all Apcupsd supported devices. The Apcupsd project supports many serial, USB and networked APC UPS.
See the [apcupsd-ups\(8\)](#) man page for more information.

2.8.4 UPS Shutdowns

`upsdrvctl` can also shut down (power down) all of your UPS hardware.



Warning

if you play around with this command, expect your filesystems to die. Don't power off your computers unless they're ready for it:

```
/usr/local/ups/sbin/upsdrvctl shutdown
/usr/local/ups/sbin/upsdrvctl shutdown sparky
```

You should read the [Configuring automatic UPS shutdowns](#) chapter to learn more about when to use this feature. If called at the wrong time, you may cause data loss by turning off a system with a filesystem mounted read-write.

2.8.5 Power distribution unit management

NUT also provides an advanced support for power distribution units.

You should read the [NUT outlets management and PDU notes](#) chapter to learn more about when to use this feature.

2.9 Network Server

`upsd` is responsible for passing data from the drivers to the client programs via the network. It should be run immediately after `upsdrvctl` in your system's startup scripts.

`upsd` should be kept running whenever possible, as it is the only source of status information for the monitoring clients like `upsmo`.

2.10 Monitoring client

`upsmon` provides the essential feature that you expect to find in UPS monitoring software: safe shutdowns when the power fails. In the layered scheme of NUT software, it is a client. It has this separate section in the documentation since it is so important. You configure it by telling it about UPSes that you want to monitor in `upsmon.conf`. Each UPS can be defined as one of two possible types: a "primary" or "secondary".

2.10.1 Primary

The monitored UPS possibly supplies power to this system running `upsmon`, but more importantly — this system can manage the UPS (typically, this instance of `upsmon` runs on the same system as the `upsd` and driver(s)): it is capable and responsible for shutting it down when the battery is depleted (or in another approach, lingering to deplete it or to tell the UPS to reboot its load after too much time has elapsed and this system is still alive — meaning wall power returned at a "wrong" moment).

The shutdown of this (primary) system itself, as well as eventually an UPS shutdown, occurs after any secondary systems ordered to shut down first have disconnected, or a critical urgency threshold was passed.

If your UPS is plugged directly into a system's serial or USB port, the `upsmon` process on that system should define its relation to that UPS as a primary. It may be more complicated for higher-end UPSes with a shared network management capability (typically via SNMP) or several serial/USB ports that can be used simultaneously, and depends on what vendors and drivers implement. Setups with several competing primaries (for redundancy) are technically possible, if each one runs its own full stack of NUT, but results can be random (currently NUT does not provide a way to coordinate several entities managing the same device).

For a typical home user, there's one computer connected to one UPS. That means you would run on the same computer the whole NUT stack — a suitable driver, `upsd`, and `upsmon` in primary mode.

2.10.2 Secondary

The monitored UPS may supply power to the system running `upsmon` (or alternatively, it may be a monitoring station with zero PSUs fed by that UPS), but more importantly, this system can't manage the UPS — e.g. shut it down directly (through a locally running NUT driver).

Use this mode when you run multiple computers on the same UPS. Obviously, only one can be connected to the serial or USB port on a typical UPS, and that system is the primary. Everything else is a secondary.

For a typical home user, there's one computer connected to one UPS. That means you run a driver, `upsd`, and `upsmon` in primary mode.

2.10.3 Additional Information

More information on configuring `upsmon` can be found in these places:

- The [upsmon\(8\)](#) man page
- [Typical setups for big servers](#)
- [Configuring automatic UPS shutdowns](#) chapter
- The stock `upsmon.conf` that comes with the package

2.11 Clients

Clients talk to `upsd` over the network and do useful things with the data from the drivers. There are tools for command line access, and a few special clients which can be run through your web server as CGI programs.

For more details on specific programs, refer to their man pages.

2.11.1 upsc

`upsc` is a simple client that will display the values of variables known to `upsd` and your UPS drivers. It will list every variable by default, or just one if you specify an additional argument. This can be useful in shell scripts for monitoring something without writing your own network code.

`upsc` is a quick way to find out if your driver(s) and `upsd` are working together properly. Just run `upsc <ups>` to see what's going on, i.e.:

```
morbo:~$ upsc sparky@localhost
ambient.humidity: 035.6
ambient.humidity.alarm.maximum: NO,NO
ambient.humidity.alarm.minimum: NO,NO
ambient.temperature: 25.14
...
```

If you are interested in writing a simple client that monitors `upsd`, the source code for `upsc` is a good way to learn about using the `upsclient` functions.

See the [upsc\(8\)](#) man page and [NUT command and variable naming scheme](#) for more information.

2.11.2 upslog

`upslog` will write status information from `upsd` to a file at set intervals. You can use this to generate graphs or reports with other programs such as `gnuplot`.

2.11.3 upsrw

`upsrw` allows you to display and change the read/write variables in your UPS hardware. Not all devices or drivers implement this, so this may not have any effect on your system.

A driver that supports read/write variables will give results like this:

```
$ upsrw sparky@localhost

( many skipped )

[ups.test.interval]
Interval between self tests
Type: ENUM
Option: "1209600"
Option: "604800" SELECTED
Option: "0"

( more skipped )
```

On the other hand, one that doesn't support them won't print anything:

```
$ upsrw fenton@gearbox

( nothing )
```

`upsrw` requires administrator powers to change settings in the hardware. Refer to [upsd.users\(5\)](#) for information on defining users in `upsd`.

2.11.4 upscmd

Some UPS hardware and drivers support the notion of an instant command - a feature such as starting a battery test, or powering off the load. You can use `upscmd` to list or invoke instant commands if your hardware/drivers support them.

Use the `-l` command to list them, like this:

```
$ upscmd -l sparky@localhost
Instant commands supported on UPS [sparky@localhost]:
```

```
load.on - Turn on the load immediately
test.panel.start - Start testing the UPS panel
calibrate.start - Start run time calibration
calibrate.stop - Stop run time calibration
...
```

`upscmd` requires administrator powers to start instant commands. To define users and passwords in `upsd`, see [upsd.users\(5\)](#).

2.12 CGI Programs

The CGI programs are clients that run through your web server. They allow you to see UPS status and perform certain administrative commands from any web browser. Javascript and cookies are not required.

These programs are not installed or compiled by default. To compile and install them, first run `configure --with-cgi`, then do `make` and `make install`. If you receive errors about "gd" during configure, go get it and install it before continuing.

You can get the source here:

<http://www.libgd.org/>

In the event that you need `libpng` or `zlib` in order to compile `gd`, they can be found at these URLs:

<http://www.libpng.org/pub/png/pngcode.html>

<http://www.gzip.org/zlib/>

2.12.1 Access Restrictions

The CGI programs use `hosts.conf` to see if they are allowed to talk to a host. This keeps malicious visitors from creating queries from your web server to random hosts on the Internet.

If you get error messages that say "Access to that host is not authorized", you're probably missing an entry in your `hosts.conf`.

2.12.2 upsstats

`upsstats` generates web pages from HTML templates, and plugs in status information in the right places. It looks like a distant relative of APC's old Powerchute interface. You can use it to monitor several systems or just focus on one.

It also can generate IMG references to `upsimage`.

2.12.3 upsimage

This is usually called by `upsstats` via IMG SRC tags to draw either the utility or outgoing voltage, battery charge percent, or load percent.

2.12.4 upsset

`upsset` provides several useful administration functions through a web interface. You can use `upsset` to kick off instant commands on your UPS hardware like running a battery test. You can also use it to change variables in your UPS that accept user-specified values.

Essentially, `upsset` provides the functions of `upswr` and `upscmd`, but with a happy pointy-clicky interface.

`upsset` will not run until you convince it that you have secured your system. You **must** secure your CGI path so that random interlopers can't run this program remotely. See the `upsset.conf` file. Once you have secured the directory, you can enable this program in that configuration file. It is not active by default.

2.13 Version Numbering

The version numbers work like this: if the middle number is odd, it's a development tree, otherwise it is the stable tree.

The past stable trees were 1.0, 1.2, 1.4, 2.0, 2.2 and 2.4, with the latest stable tree designated 2.6. The development trees were 1.1, 1.3, 1.5, 2.1 and 2.3. As of the 2.4 release, there is no real development branch anymore since the code is available through a revision control system (namely Subversion) and snapshots. Since 2.7 line of releases, sources are tracked in Git revision control system, with the project ecosystem being hosted on GitHub, and improvements or other contributions merged through common pull request approach and custom NUT CI testing on multiple platforms.

Major release jumps are mostly due to large changes to the features list. There have also been a number of architectural changes which may not be noticeable to most users, but which can impact developers.

2.14 Backwards and Forwards Compatibility

The old network code spans a range from about 0.41.1 when TCP support was introduced up to the recent 1.4 series. It used variable names like `STATUS`, `UTILITY`, and `LOADPCT`. Many of these names go back to the earliest prototypes of this software from 1997. At that point there was no way to know that so many drivers would come along and introduce so many new variables and commands. The resulting mess grew out of control over the years.

During the 1.3 development cycle, all variables and instant commands were renamed to fit into a tree-like structure. There are major groups, like input, output and battery. Members of those groups have been arranged to make sense - `input.voltage` and `output.voltage` compliment each other. The old names were `UTILITY` and `OUTVOLT`. The benefits in this change are obvious.

The 1.4 clients can talk to either type of server, and can handle either naming scheme. 1.4 servers have a compatibility mode where they can answer queries for both names, even though the drivers are internally using the new format.

When 1.4 clients talk to 1.4 or 2.0 (or more recent) servers, they will use the new names.

Here's a table to make it easier to visualize:

Client version	Server version			
	1.0	1.2	1.4	2.0+
1.0	yes	yes	yes	no
1.2	yes	yes	yes	no
1.4	yes	yes	yes	yes
2.0+	no	no	yes	yes

Version 2.0, and more recent, do not contain backwards compatibility for the old protocol and variable/command names. As a result, 2.0 clients can't talk to anything older than a 1.4 server. If you ask a 2.0 client to fetch "`STATUS`", it will fail. You'll have to ask for "`ups.status`" instead.

Authors of separate monitoring programs should have used the 1.4 series to write support for the new variables and command names. Client software can easily support both versions as long as they like. If `upsd` returns `ERR UNKNOWN-COMMAND` to a GET request, you need to use REQ.

2.15 Support / Help / etc.

If you are in need of help, refer to the [Support instructions](#) in the user manual.

2.16 Hacking / Development Info

Additional documentation can be found in:

- the [Developer Guide](#),
- the [Packager Guide](#).

2.17 Acknowledgements / Contributions

The many people who have participated in creating and improving NUT are listed in the user manual [acknowledgements appendix](#).

3 Features

Two NUT websites

This version of the page reflects NUT release *v2.8.0* with codebase committed ff16dabca at 2022-04-04T11:04:28+00:00. Options, features and capabilities in current development (and future releases) are detailed on the main site and may differ from ones described here.

NUT provides many features, and is always improving. Thus this list may lag behind the current code.

Features frequently appear during the development cycles, so be sure to look at the [release notes and change logs](#) to see the latest additions.

3.1 Multiple manufacturer and device support

- Monitors many UPS, PDU, ATS, PSU and SCD models from more than 140 manufacturers with a unified interface ([Hardware Compatibility List](#)).
- Various communication types and many protocols are supported with the same common interface:
 - serial,
 - USB,
 - network (SNMP, Eaton / MGE XML/HTTP).

3.2 Multiple architecture support

- Cross-platform — different flavors of Unix can be managed together with a common set of tools, even crossing architectures.
 - This software has been reported to run on Linux distributions, the BSDs, Apple's OS X, commercial Solaris and open-source illumos distros, IRIX, HP/UX, Tru64 Unix, and AIX.
 - Windows users may be able to build it directly with Cygwin. There is also a port of the client-side monitoring to Windows called WinNUT.
 - Your system will probably run it too. You just need a good C compiler and possibly some more packages to gain access to the serial ports. Other features, such as USB / SNMP / whatever, will also need extra software installed.
-

3.3 Layered and modular design with multiple processes

- Three layers: drivers, server, clients.
- Drivers run on the same host as the server, and clients communicate with the server over the network.
- This means clients can monitor any UPS anywhere as long as there is a network path between them.



Warning

Be sure to plug your network's physical hardware (switches, hubs, routers, bridges, . . .) into the UPS!

3.4 Redundancy support — Hot swap/high availability power supplies

- upsmon can handle high-end servers which receive power from multiple UPSes simultaneously.
- upsmon won't initiate a shutdown until the total power situation across all source UPSes becomes critical (on battery and low battery).
- You can lose a UPS completely as long as you still have at least the minimum number of sources available. The minimum value is configurable.

3.5 Security and access control

- Manager functions are granted with per-user granularity. The admin can have full powers, while the admin's helper can only do specific non-destructive tasks such as a battery test (beware that with a worn-out battery whose replacement is a few years overdue, a "capacity/remaining runtime" test can still be destructive by powering off the load abruptly — and also such a test can cause hosts to hide into graceful shutdowns when the battery state does get critical as part of the test).
- The drivers, server, and monitoring client (upsmon) can all run as separate user IDs if this is desired for privilege separation.
- Only one tiny part of one program has root powers. upsmon starts as root and forks an unprivileged process which does the actual monitoring over the network. They remain connected over a pipe. When a shutdown is necessary, a single character is sent to the privileged process. It then calls the predefined shutdown command. In any other case, the privileged process exits. This was inspired by the auth mechanism in Solar Designer's excellent popa3d.
- The drivers and network server may be run in a chroot jail for further security benefits. This is supported directly since version 1.4 and beyond with the *chroot=* configuration directive.
- IP-based access control relies on the local firewall and [TCP Wrapper](#).
- SSL is available as a build option ("*--with-ssl*"). It encrypts sessions with upsd and can also be used to authenticate servers.

3.6 Web-based monitoring

- Comes stock with CGI-based web interface tools for UPS monitoring and management, including graphical status displays.
- Custom status web pages may be generated with the CGI programs, since they use templates to create the pages. This allows you to have status pages which fit the look and feel of the rest of your site.

3.7 Free software

- That's free beer and free speech. Licensed under the GNU General Public License version 2 or later.
 - Know your systems — all source code is available for inspection, so there are no mysteries or secrets in your critical monitoring tools.
-

3.8 UPS management and control

- Writable variables may be edited on higher end equipment for local customization
- Status monitoring can generate notifications (email/pager/SMS/...) on alert conditions
- Alert notices may be dampened to only trigger after a condition persists. This avoids the usual pager meltdown when something happens and no delay is used.
- Maintenance actions such as battery runtime calibration are available where supported by the UPS hardware.
- Power statistics can be logged in custom formats for later retrieval and analysis
- All drivers are started and stopped with one common program. Starting one is as easy as starting ten: `upsdrvctl start`.
- For operating systems with a supported service management framework, you can manage the NUT drivers wrapped into independent service instances using the `upsdrvsvctl` instead, and gain the benefits of automated restart as well as possibility to define further dependencies between your OS components.
- Shutdowns and other procedures may be tested without stressing actual UPS hardware by simulating status values with the dummy-ups pseudo-driver. Anything that can happen in a driver can be replicated with dummy-ups.

3.9 Monitoring diagrams

These are the most common situations for monitoring UPS hardware. Other ways are possible, but they are mostly variations of these four.

Note

these examples show serial communications for simplicity, but USB or SNMP or any other monitoring is also possible.

3.9.1 "Simple" configuration



One UPS, one computer. This is also known as "Standalone" configuration.

This is the configuration that most users will use. You need at least a driver, `upsd`, and `upsmon` running.

3.9.2 "Advanced" configuration

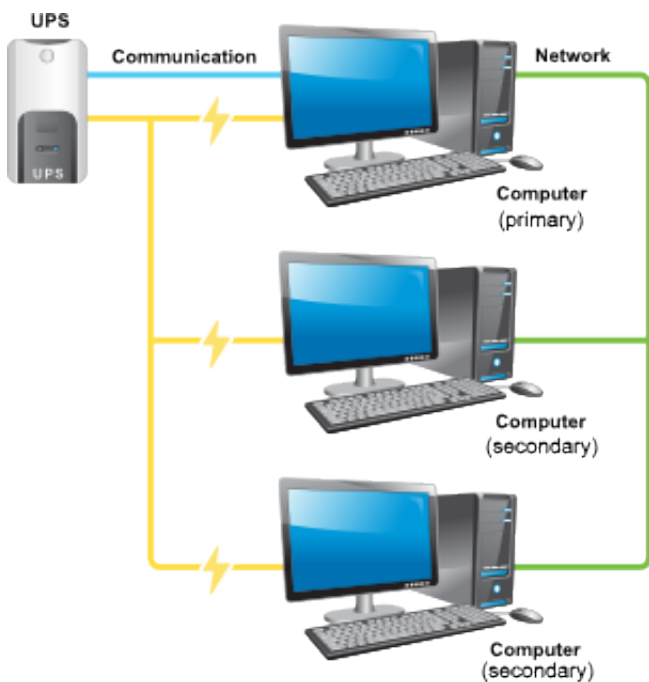

One UPS, multiple computers. Only one of them can actually talk to the UPS directly. That's where the network comes in:

- The Primary system runs the relevant driver, `upsd`, and `upsmou` in "primary" mode.
- The Secondary systems only run `upsmou` in "secondary" mode which all connect to `upsd` on Primary.

This is useful when you have a very large UPS that's capable of running multiple systems simultaneously. There is no longer the need to buy a bunch of individual UPSes or "sharing" hardware, since this software will handle the sharing for you.

3.9.3 "Big Box" configuration



Some systems have multiple power supplies and cords. You typically find this on high-end servers that allow hot-swap and other fun features. In this case, you run multiple drivers (one per UPS), a single `upsd`, and a single `upsmou` (as a primary for both UPS 1 and UPS 2)

This software understands that some of these servers can also run with some of the supplies gone. For this reason, every UPS is assigned a "power value" — the quantity of power supplies that it feeds on this system.

The total available "power value" is compared to the minimum that is required for that hardware. For example, if you have 3 power supplies and 3 UPSes, but only 2 supplies must be running at any given moment, the minimum would be 2.

This means that you can safely lose any one UPS and the software will handle it properly by remaining online and not causing a shut down.

3.9.4 "Bizarre" configuration

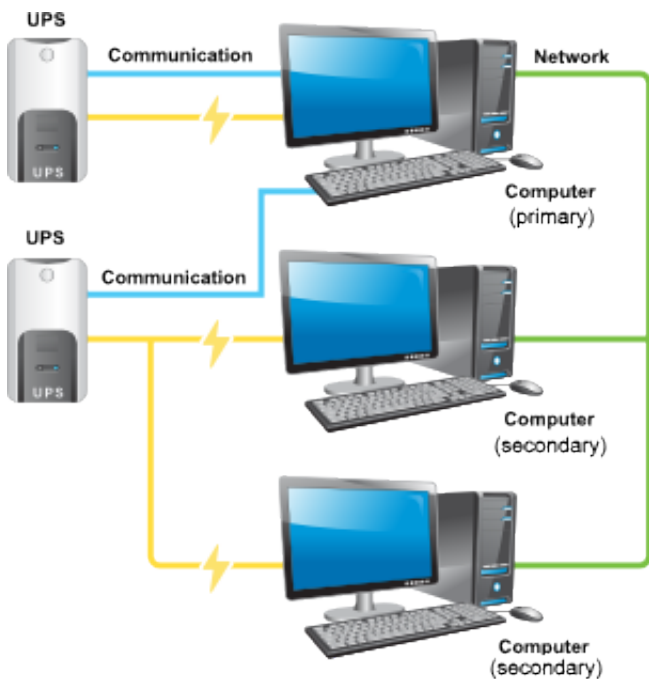

You can even have a UPS that has the serial port connected to a system that it's not feeding. Sometimes a PC will be close to a UPS that needs to be monitored, so it's drafted to supply a serial port for the purpose. This PC may in fact be getting its own power from some other UPS. This is not a problem for the set-up.

The first system ("mixed") is a Primary for UPS 1, but is only monitoring UPS 2. The other systems are Secondaries of UPS 2.

3.10 Image credits

Thanks to Eaton for providing shiny modern graphics.

3.11 Compatibility information

3.11.1 Hardware

The current list of hardware supported by NUT can be viewed [here](#).

3.11.2 Operating systems

This software has been reported to run on:

- Linux distributions,
- the BSDs,
- Apple's OS X,
- Sun Solaris,
- SGI IRIX,
- HP/UX,
- Tru64 Unix,

- AIX.

There is also a port of the client-side monitoring to Windows called WinNUT. Windows users may be able to build it directly with Cygwin.

Your system will probably run it too. You just need a good C compiler and possibly some more packages to gain access to the serial ports. Other features, such as USB / SNMP / whatever, will also need extra software installed.

Success reports are welcomed to keep this list accurate.

4 Download information

Two NUT websites

This version of the page reflects NUT release *v2.8.0* with codebase committed ff16dabca at 2022-04-04T11:04:28+00:00
Options, features and capabilities in current development (and future releases) are detailed on the main site and may differ from ones described here.

This section presents the different methods to download NUT.

4.1 Source code

Note

You should always use PGP/GPG to verify the signatures before using any source code.
You can use the [following procedure](#). to do so.

4.1.1 Stable tree: 2.8

-
-
-
-
-
-
- [ChangeLog](#)

You can also browse the [stable source directory](#).

4.1.2 Development tree:

Code repository

The development tree is available through a Git repository hosted at [GitHub](#).

To retrieve the current development tree, use the following command:

```
$ git clone git://github.com/networkupstools/nut.git
```

The configure script and its dependencies are not stored in Git. To generate them, ensure that autoconf, automake and libtool are installed, then run the following script in the directory you just checked out:

```
$ ./autogen.sh
```

Then refer to the [NUT user manual](#) for more information.

Browse code

You can browse the "vanilla NUT" code at the [Main GitHub repository for NUT sources](#), and some possibly modified copies as part of packaging recipe sources of operating system distributions, as listed below.

Snapshots

GitHub has several download links for repository snapshots (for particular tags or branches), but you will need a number of tools such as `autoconf`, `automake` and `libtool` to use these snapshots to generate the `configure` script and some other files.

After you `configure` the source workspace, a `make dist-hash` recipe would create the snapshot tarballs which do not require the `auto*` tools, and their checksum files, such as those available on the NUT website and attached to [GitHub Releases page](#).

4.1.3 Older versions

[Browse source directory](#)

4.2 Binary packages

Note

The only official releases from this project are source code.

NUT is already available in the following operating systems (and [likely more](#)):

- [Repology report on NUT](#) lists 745 entries about NUT, as of this writing
 - Linux:
 - [42ITY.org packaging recipes for Debian-based releases](#)
 - [Debian Salsa recipes](#) and [Debian packages](#)
 - [Ubuntu packages](#)
 - [Fedora Rawhide recipes](#) and [Red Hat / Fedora packages](#)
 - [Arch Linux recipe](#) and [Arch Linux package info](#)
 - [Gentoo Linux recipe](#) and [Gentoo Linux package info](#)
 - [Novell SUSE / openSUSE official package base recipe](#) and [Novell SUSE / openSUSE official package development recipe](#), and [Novell SUSE / openSUSE official package overview](#)
 - [Numerous other recipes on Open Build System \(not only by SUSE\)](#)
 - [OpenWRT recipes](#)
 - [Slackware package overview](#)
 - [Void Linux recipes](#)
 - BSD systems:
 - [FreeBSD package recipe \(devel\)](#), [FreeBSD package recipe](#) and [FreeBSD package overview](#)
 - [NetBSD recipe](#) and [NetBSD package overview](#)
 - [OpenBSD recipe](#)
 - [FreeNAS iocage-ports recipe](#), [FreeNAS 9.3 docs on UPS integration](#) and [FreeNAS 11.3-U5 docs on UPS integration](#)
 - Mac OS X:
-

- [Fink recipe](#) and [Fink package overview](#)
- [MacPorts recipe](#)
- illumos/Solaris:
 - [OpenIndiana oi-userland recipe](#) and [OpenIndiana latest rolling builds](#)
- Windows (complete port, Beta):
 - [Windows MSI installer 2.6.5-6](#)

4.3 Java packages

- The jNut package has been split into its own [GitHub repository](#).
- NUT Java support (client side, Beta) [jNUT 0.2-SNAPSHOT](#)
- NUT Java Web support (client side using REST, Beta) [jNutWebAPI 0.2-SNAPSHOT \(sources\)](#)

4.4 Virtualization packages

4.4.1 VMware

- NUT client 2.7.4 for ESXi 5.0, 5.1, 5.5 and 6.0 (offsite, René Garcia)
 - [blog entry \(French\)](#)
 - [VIB package \(v1.4.0\)](#)

5 Installation instructions

This chapter describes the various methods for installing Network UPS Tools.

Whenever it is possible, prefer [installing from packages](#). Packagers have done an excellent and hard work at improving NUT integration into their system. On the other hand, distributions and appliances tend to package "official releases" of projects such as NUT, and so do not deliver latest and greatest fixes, new drivers, bugs and other features.

5.1 Installing from source

These are the essential steps for compiling and installing this software.

The NUT [Packager Guide](#), which presents the best practices for installing and integrating NUT, is also a good reading.

The [Prerequisites for building NUT on different OSes](#) document suggests prerequisite packages with tools and dependencies available and needed to build and test as much as possible of NUT on numerous platforms, written from perspective of CI testing (if you are interested in getting updated drivers for a particular device, you might select a sub-set of those suggestions).

Keep in mind that...

- the paths shown below are the default values you get by just calling `configure` by itself. If you have used `--prefix` or similar, things will be different. Also, if you didn't install this program from source yourself, the paths will probably have a number of differences.
- by default, your system probably won't find the man pages, since they install to `/usr/local/ups/man`. You can fix this by editing your `MANPATH`, or just do this:

```
man -M /usr/local/ups/man <man page>
```

- if your favorite system offers up to date binary packages, you should always prefer these over a source installation. Along with the known advantages of such systems for installation, upgrade and removal, there are many integration issues that have been addressed.
-

5.1.1 Prepare your system

System User creation

Create at least one system user and a group for running this software. You might call them "ups" and "nut". The exact names aren't important as long as you are consistent.

The process for doing this varies from one system to the next, and explaining how to add users is beyond the scope of this document.

For the purposes of this document, the user name and group name will be *ups* and *nut* respectively.

Be sure the new user is a member of the new group! If you forget to do this, you will have problems later on when you try to start `upsd`.

5.1.2 Build and install

Configuration

Configure the source tree for your system. Add the `--with-user` and `--with-group` switch to set the user name and group that you created above.

```
./configure --with-user=ups --with-group=nut
```

If you need any other switches for `configure`, add them here. For example:

- to build and install USB drivers, add `--with-usb` (note that you need to install `libusb` development package or files).
- to build and install SNMP drivers, add `--with-snmp` (note that you need to install `libsnmp` development package or files).
- to build and install CGI scripts, add `--with-cgi`.

See [Configure options](#) from the User Manual, `docs/configure.txt` or `./configure --help` for all the available options.

If you alter paths with additional switches, be sure to use those new paths while reading the rest of the steps.

Reference: [Configure options](#) from the User Manual.

Build the programs

```
make
```

This will build the NUT client and server programs and the selected drivers. It will also build any other features that were selected during [configuration](#) step above.

Installation

Note

you should now gain privileges for installing software if necessary:

```
su
```

Install the files to a system level directory:

```
make install
```

This will install the compiled programs and man pages, as well as some data files required by NUT. Any optional features selected during configuration will also be installed.

This will also install sample versions of the NUT configuration files. Sample files are installed with names like `ups.conf.sample` so they will not overwrite any existing real config files you may have created.

If you are packaging this software, then you will probably want to use the `DESTDIR` variable to redirect the build into another place, i.e.:

```
make DESTDIR=/tmp/package install
make DESTDIR=/tmp/package install-conf
```

State path creation

Create the state path directory for the driver(s) and server to use for storing UPS status data and other auxiliary files, and make it group-writable by the group of the system user you created.

```
mkdir -p /var/state/ups
chmod 0770 /var/state/ups
chown root:nut /var/state/ups
```

Ownership and permissions

Set ownership data and permissions on your serial or USB ports that go to your UPS hardware. Be sure to limit access to just the user you created earlier.

These examples assume the second serial port (`ttyS1`) on a typical Slackware system. On FreeBSD, that would be `cuaa1`. Serial ports vary greatly, so yours may be called something else.

```
chmod 0660 /dev/ttyS1
chown root:nut /dev/ttyS1
```

The setup for USB ports is slightly more complicated. Device files for USB devices, such as `/proc/bus/usb/002/001`, are usually created "on the fly" when a device is plugged in, and disappear when the device is disconnected. Moreover, the names of these device files can change randomly. To set up the correct permissions for the USB device, you may need to set up (operating system dependent) hotplugging scripts. Sample scripts and information are provided in the `scripts/hotplug` and `scripts/udev` directories. For most users, the hotplugging scripts will be installed automatically by "make install".

(If you want to try if a driver works without setting up hotplugging, you can add the `-u root` option to `upsd`, `upsmon`, and `drivers`; this should allow you to follow the below instructions. However, don't forget to set up the correct permissions later!).

Note

if you are using something like `udev` or `devd`, make sure these permissions stay set across a reboot. If they revert to the old values, your drivers may fail to start.

You are now ready to configure NUT, and start testing and using it.

You can jump directly to the [NUT configuration](#).

5.2 Installing from packages

This chapter describes the specific installation steps when using binary packages that exist on various major systems.

5.2.1 Debian, Ubuntu and other derivatives

Note

NUT is packaged and well maintained in these systems. The official Debian packager is part of the NUT Team.

Using your preferred method (`apt-get`, `aptitude`, `Synaptic`, ...), install the `nut` package, and optionally the following:

- `nut-cgi`, if you need the CGI (HTML) option,
- `nut-snmp`, if you need the snmp-ups driver,
- `nut-xml`, for the netxml-ups driver,
- `nut-powerman-pdu`, to control the PowerMan daemon (PDU management)
- `nut-dev`, if you need the development files.

Configuration files are located in `/etc/nut`. `nut.conf(5)` must be edited to be able to invoke `/etc/init.d/nut`

Note

Ubuntu users can access the APT URL installation by clicking on [this link](#).

5.2.2 Mandriva

Note

NUT is packaged and well maintained in these systems. The official Mandriva packager is part of the NUT Team.

Using your preferred method (`urpmi`, `RPMdrake`, ...), install one of the two below packages:

- `nut-server` if you have a *standalone* or *netserver* installation,
- `nut` if you have a *netclient* installation.

Optionally, you can also install the following:

- `nut-cgi`, if you need the CGI (HTML) option,
- `nut-devel`, if you need the development files.

5.2.3 SUSE / openSUSE

Note

NUT is packaged and well maintained in these systems. The official SUSE packager is part of the NUT Team.

Install the `nut-classic` package, and optionally the following:

- *nut-drivers-net*, if you need the *snmp-ups* or the *netxml-ups* drivers,
- *nut-cgi*, if you need the CGI (HTML) option,
- *nut-devel*, if you need the development files,

Note

SUSE and openSUSE users can use the [one-click install method](#) to install NUT.

5.2.4 Red Hat, Fedora and CentOS

Note

NUT is packaged and well maintained in these systems. The official Red Hat packager is part of the NUT Team.

Using your preferred method (*yum*, *Add/Remove Software*, ...), install one of the two below packages:

- *nut* if you have a *standalone* or *netserver* installation,
- *nut-client* if you have a *netclient* installation.

Optionally, you can also install the following:

- *nut-cgi*, if you need the CGI (HTML) option,
- *nut-xml*, if you need the *netxml-ups* driver,
- *nut-devel*, if you need the development files.

5.2.5 FreeBSD

You can either install NUT as a binary package or as a port.

Binary package

To install NUT as a package execute:

```
# pkg install nut
```

Port

The port is located under `sysutils/nut`. Use `make config` to select configuration options, e.g. to build the optional CGI scripts. To install it, use:

```
# make install clean
```

USB UPS on FreeBSD

For USB UPS devices the NUT package/port installs devd rules in `/usr/local/etc/devd/nut-usb.conf` to set USB device permissions. `devd` needs to be restarted for these rules to apply:

```
# service devd restart
```

(Re-)connect the device after restarting `devd` and check that the USB device has the proper permissions. Check the last entries of the system message buffer. You should find an entry like

```
# dmesg | tail
[...]
ugen0.2: <INNO TECH USB to Serial> at usb0
```

The device file must be owned by group `uucp` and must be group read-/writable. In the example from above this would be

```
# ls -Ll /dev/ugen0.2
crw-rw----  1 root  uucp  0xa5 Mar 12 10:33 /dev/ugen0.2
```

If the permissions are not correct, verify that your device is registered in `/usr/local/etc/devd/nut-usb.conf`. The vendor and product id can be found using:

```
# usbconfig -u 0 -a 2 dump_device_desc
```

where `-u` specifies the USB bus number and `-a` specifies the USB device index.

You are now ready to configure NUT, and start testing and using it.

You can jump directly to the [NUT configuration](#).

6 Configuration notes

Two NUT websites

This version of the page reflects NUT release `v2.8.0` with codebase committed `ff16dabca` at `2022-04-04T11:04:28+00:00`. Options, features and capabilities in current development (and future releases) are detailed on the main site and may differ from ones described here.

This chapter describe most of the configuration and use aspects of NUT, including establishing communication with the device and configuring safe shutdowns when the UPS battery runs out of power.

There are many programs and [features](#) in this package. You should check out the [NUT Overview](#) and other accompanying documentation to see how it all works.

Note

NUT does not currently provide proper graphical configuration tools. However, there is now support for [Augeas](#), which will enable the easier creation of configuration tools. Moreover, [nut-scanner\(8\)](#) is available to discover supported devices (USB, SNMP, Eaton XML/HTTP and IPMI) and NUT servers (using Avahi or the classic connection method).

6.1 Details about the configuration files

6.1.1 Generalities

All configuration files within this package are parsed with a common state machine, which means they all can use a number of extras described here.

First, most of the programs use an uppercase word to declare a configuration directive. This may be something like MONITOR, NOTIFYCMD, or ACCESS. The case does matter here. "monitor" won't be recognized.

Next, the parser does not care about whitespace between words. If you like to indent things with tabs or spaces, feel free to do it here.

If you need to set a value to something containing spaces, it has to be contained within "quotes" to keep the parser from splitting up the line. That is, you want to use something like this:

```
SHUTDOWNCMD "/sbin/shutdown -h +0"
```

Without the quotes, it would only see the first word on the line.

OK, so let's say you really need to embed that kind of quote within your configuration directive for some reason. You can do that too.

```
NOTIFYCMD "/bin/notifyme -foo -bar \"hi there\" -baz"
```

In other words, \ can be used to escape the " .

Finally, for the situation where you need to put the \ character into your string, you just escape it.

```
NOTIFYCMD "/bin/notifyme c:\\dos\\style\\path"
```

The \ can actually be used to escape any character, but you only really need it for \, ", and # as they have special meanings to the parser.

When using file names with space characters, you may end up having tricky things since you need to write them inside "" which must be escaped:

```
NOTIFYCMD "\"c:\\path with space\\notifyme\" \"c:\\path with space\\name\""
```

is the comment character. Anything after an unescaped # is ignored.

Something like this...

```
identity = my#lups
```

will actually turn into `identity = my`, since the # stops the parsing. If you really need to have a # in your configuration, then escape it.

```
identity = my\\#lups
```

Much better.

The = character should be used with care too. There should be only one "simple" = character in a line: between the parameter name and its value. All other = characters should be either escaped or within "quotes".

```
password = 123=123
```

is incorrect. You should use:

```
password = 123\\=123
```

or:

```
password = "123=123"
```

6.1.2 Line spanning

You can put a backslash at the end of the line to join it to the next one. This creates one virtual line that is composed of more than one physical line.

Also, if you leave the "" quote container open before a newline, it will keep scanning until it reaches another one. If you see bizarre behavior in your configuration files, check for an unintentional instance of quotes spanning multiple lines.

6.2 Basic configuration

This chapter describes the base configuration to establish communication with the device.

This will be sufficient for PDU. But for UPS and SCD, you will also need to configure [automatic shutdowns for low battery events](#).



On operating systems with service management frameworks (such as Linux `systemd` and Solaris/illumos SMF), the life-cycle of driver, data server and monitoring client daemons is managed respectively by `nut-driver` (multi-instance service), `nut-server` and `nut-monitor` services. These are in turn wrapped by an "umbrella" service (or `systemd` "target") conveniently called `nut` which allows to easily start or stop all those of the bundled services, which are enabled on a particular deployment.

6.2.1 Driver configuration

Create one section per UPS in `ups.conf`

Note

The default path for a source installation is `/usr/local/ups/etc`, while packaged installation will vary. For example, `/etc/nut` is used on Debian and derivatives, while `/etc/ups` or `/etc/upsd` is used on RedHat and derivatives.

To find out which driver to use, check the [Hardware Compatibility List](#), or `data/driver.list(.in)` source file.

Once you have picked a driver, create a section for your UPS in `ups.conf`. You must supply values at least for "driver" and "port".

Some drivers may require other flags or settings. The "desc" value is optional, but is recommended to provide a better description of what useful load your UPS is feeding.

A typical device without any extra settings looks like this:

```
[mydevice]
  driver = mydriver
  port = /dev/ttyS1
  desc = "Workstation"
```

Note

USB drivers (such as `usbhid-ups` for non-SHUT mode, `nutdrv_qx` for non-serial mode, `bcmxcp_usb`, `tripplite_usb`, `blazer_usb`, `riello_usb` and `richcomm_usb`) are special cases and ignore the `port` value.

You must still set this value, but it does not matter what you set it to; a common and good practice is to set `port` to `auto`, but you can put whatever you like.

If you only own one USB UPS, the driver will find it automatically.

If you own more than one, refer to the driver's manual page for more information on matching a specific device.

References: [ups.conf\(5\)](#), [nutupsdrv\(8\)](#), [bcmxcp_usb\(8\)](#), [blazer\(8\)](#), [nutdrv_qx\(8\)](#), [richcomm_usb\(8\)](#), [riello_usb\(8\)](#), [tripplite_usb\(8\)](#), [usbhid-ups\(8\)](#)

6.2.2 Starting the driver(s)

Generally, you can just start the driver(s) for your hardware (all sections defined in *ups.conf*) using the following command:

```
upsdrvctl start
```

Make sure the driver doesn't report any errors. It should show a few details about the hardware and then enter the background. You should get back to the command prompt a few seconds later. For reference, a successful start of the `usbhid-ups` driver looks like this:

```
# upsdrvctl start
Network UPS Tools - Generic HID driver 0.34 (2.4.1)
USB communication driver 0.31
Using subdriver: MGE HID 1.12
Detected EATON - Ellipse MAX 1100 [ADKK22008]
```

If the driver doesn't start cleanly, make sure you have picked the right one for your hardware. You might need to try other drivers by changing the "driver=" value in *ups.conf*.

Be sure to check the driver's man page to see if it needs any extra settings in *ups.conf* to detect your hardware.

If it says `can't bind /var/state/ups/...` or similar, then your state path probably isn't writable by the driver. Check the [permissions and mode on that directory](#) vs. the user account your driver starts as.

After making changes, try the [Ownership and permissions](#) step again.

6.2.3 Driver(s) as a service

On operating systems with init-scripts managing life-cycle of the operating environment, the `upsdrvctl` program is also commonly used in those scripts. It has a few downsides, such as that if the device was not accessible during OS startup and the driver connection timed out, it would remain not-started until an administrator (or some other script) "kicks" the driver to retry startup. Also, startup of the `upsd` data server daemon and its clients like `upsmon` is delayed until all the NUT drivers complete their startup (or time out trying).

This can be a big issue on systems which monitor multiple devices, such as big servers with multiple power sources, or administrative workstations which monitor a datacenter full of UPSes.

For this reason, NUT starting with version 2.8.0 supports startup of its drivers as independent instances of a `nut-driver` service under the Linux `systemd` and Solaris/illumos SMF service-management frameworks (corresponding files and scripts may be not pre-installed in packaging for other systems).

Such service instances have their own and independent life-cycle, including parallel driver start and stop processing, and retries of startup in case of failure as implemented by the service framework in the OS. The Linux `systemd` solution also includes a `nut-driver.target` as a checkpoint that all defined drivers have indeed started up (as well as being a singular way to enable or disable startup of drivers).

In both cases, a service named `nut-driver-enumerator` is registered, and when it is (re-)started it scans the currently defined device sections in *ups.conf* and the currently defined instances of `nut-driver` service, and brings them in sync (adding or removing service instances), and if there were changes — it restarts the corresponding drivers (via service instances) as well as the data server which only reads the list of sections at its startup. This helper service should be triggered whenever your system (re-)starts the `nut-server` service, so that it runs against an up-to-date list of NUT driver processes.

A service-oriented solution also allows to consider that different drivers have different dependencies — such as that networked drivers should begin startup after IP addresses have been assigned, while directly-connected devices might need nothing beside a mounted filesystem (or an activated USB stack service or device rule, in case of Linux). Likewise, systems administrators can define further local dependencies between services and their instances as needed on particular deployments.

This solution also adds the `upsdrvsvctl` script to manage NUT drivers as system service instances, whose CLI mimics that of `upsdrvctl` program. One addition is the `resync` argument to trigger `nut-driver-enumerator`, another is a `list` argument to display current mappings of service instances to NUT driver sections. Also, original tool's arguments such as the `-u` (user to run the driver as) or `-D` (debug of the driver) do not make sense in the service context — the accounts to use and other arguments to the driver process are part of service setup (and an administrator can manage it there).

Note that while this solution tries to register service instances with same names as NUT configuration sections for the devices, this can not always be possible due to constraints such as syntax supported by a particular service management framework. In this case, the enumerator falls back to MD5 hashes of such section names, and the `upsdrvsvct1` script supports this to map the user-friendly NUT configuration section names to actual service names that it would manage.

References: man pages: [nutupsdrv\(8\)](#), [upsdrvctl\(8\)](#), [upsdrvsvct1\(8\)](#)

6.2.4 Data server configuration (upsd)

Configure `upsd`, which serves data from the drivers to the clients.

First, edit `upsd.conf` to allow access to your client systems. By default, `upsd` will only listen to `localhost` port `3493/tcp`. If you want to connect to it from other machines, you must specify each interface you want `upsd` to listen on for connections, optionally with a port number.

```
LISTEN 127.0.0.1 3493
LISTEN :::1 3493
```

Note

Refer to the NUT user manual [security chapter](#) for information on how to access and secure `upsd` clients connections.

Next, create `upsd.users`. For now, this can be an empty file. You can come back and add more to it later when it's time to configure `upsmem` or run one of the management tools.

Do not make either file world-readable, since they both hold access control data and passwords. They just need to be readable by the user you created in the preparation process.

The suggested configuration is to `chown` it to `root`, `chgrp` it to the group you created, then make it readable by the group.

```
chown root:nut upsd.conf upsd.users
chmod 0640 upsd.conf upsd.users
```

References: man pages: [upsd.conf\(5\)](#), [upsd.users\(5\)](#), [upsd\(8\)](#)

6.2.5 Starting the data server

Start the network data server:

```
upsd
```

Make sure it is able to connect to the driver(s) on your system. A successful run looks like this:

```
# upsd
Network UPS Tools upsd 2.4.1
listening on 127.0.0.1 port 3493
listening on :::1 port 3493
Connected to UPS [eaton]: usbhid-ups-eaton
```

`upsd` prints dots while it waits for the driver to respond. Your system may print more or less depending on how many drivers you have and how fast they are.

Note

If `upsd` says that it can't connect to a UPS or that the data is stale, then your `ups.conf` is not configured correctly, or you have a driver that isn't working properly. You must fix this before going on to the next step.

Note

Normally `upsd` requires that at least one driver section is defined in the `ups.conf` file, and refuses to start otherwise. If you intentionally do not have any driver sections defined (yet) but still want the data server to run, respond and report zero devices (e.g. on an automatically managed monitoring deployment), you can enable the `ALLOW_NO_DEVICE true` option in the `upsd.conf` file.

On operating systems with service management frameworks, the data server life-cycle is managed by `nut-server` service.

Reference: man page: [upsd\(8\)](#)

6.2.6 Check the UPS data

Status data

Make sure that the UPS is providing good status data. You can use the `upsc` command-line client for this:

```
upsc myupsname@localhost ups.status
```

You should see just one line in response:

```
OL
```

OL means your system is running on line power. If it says something else (like OB—on battery, or LB—low battery), your driver was probably misconfigured during the [Driver configuration](#) step. If you reconfigure the driver, use `upsdrvctl stop` to stop it, then start it again as shown in the [Starting driver\(s\)](#) step.

Reference: man page: [upsc\(8\)](#)

All data

Look at all of the status data which is being monitored.

```
upsc myupsname@localhost
```

What happens now depends on the kind of device and driver you have. In the list, you should see `ups.status` with the same value you got above. A sample run on an UPS (Eaton Ellipse MAX 1100) looks like this:

```
battery.charge: 100
battery.charge.low: 20
battery.runtime: 2525
battery.type: PbAc
device.mfr: EATON
device.model: Ellipse MAX 1100
device.serial: ADKK22008
device.type: ups
driver.name: usbhid-ups
driver.parameter.pollfreq: 30
driver.parameter.pollinterval: 2
driver.parameter.port: auto
driver.version: 2.4.1-1988:1990M
driver.version.data: MGE HID 1.12
driver.version.internal: 0.34
input.sensitivity: normal
input.transfer.boost.low: 185
input.transfer.high: 285
input.transfer.low: 165
input.transfer.trim.high: 265
```

```
input.voltage.extended: no
outlet.1.desc: PowerShare Outlet 1
outlet.1.id: 2
outlet.1.status: on
outlet.1.switchable: no
outlet.desc: Main Outlet
outlet.id: 1
outlet.switchable: no
output.frequency.nominal: 50
output.voltage: 230.0
output.voltage.nominal: 230
ups.beeper.status: enabled
ups.delay.shutdown: 20
ups.delay.start: 30
ups.firmware: 5102AH
ups.load: 0
ups.mfr: EATON
ups.model: Ellipse MAX 1100
ups.power.nominal: 1100
ups.productid: ffff
ups.serial: ADKK22008
ups.status: OL CHRG
ups.timer.shutdown: -1
ups.timer.start: -1
ups.vendorid: 0463
```

Reference: man page: [upsc\(8\)](#), [NUT command and variable naming scheme](#)

6.2.7 Startup scripts

Note

This step is not necessary if you installed from packages.

Edit your startup scripts, and make sure `upsdrvctl` and `upsd` are run every time your system starts. In newer versions of NUT, you may have a `nut.conf` file which sets the `MODE` variable for bundled init-scripts, to facilitate enabling of certain features in the specific end-user deployments.

If you installed from source, check the `scripts` directory for reference init-scripts, as well as `systemd` or `SMF` service methods and manifests.

6.3 Configuring automatic shutdowns for low battery events

The whole point of UPS software is to bring down the OS cleanly when you run out of battery power. Everything else is roughly eye candy.

To make sure your system shuts down properly, you will need to perform some additional configuration and run `upsmon`. Here are the basics.

6.3.1 Shutdown design

When your UPS batteries get low, the operating system needs to be brought down cleanly. Also, the UPS load should be turned off so that all devices that are attached to it are forcibly rebooted, and subsequently start in the predictable order and state suitable for your data center.

Here are the steps that occur when a critical power event happens, for the simpler case of one UPS device feeding one or several systems:

1. The UPS goes on battery
2. The UPS reaches low battery (a "critical" UPS), that is to say, `upsc` displays:

```
ups.status: OB LB
```

The exact behavior depends on the specific device, and is related to such settings and readings as:

- `battery.charge` and `battery.charge.low`
 - `battery.runtime` and `battery.runtime.low`
3. The `upsmon` primary notices the "critical UPS" situation and sets "FSD" — the "forced shutdown" flag to tell all secondary systems that it will soon power down the load.

Warning



By design, since we require power-cycling the load and don't want some systems to be powered off while others remain running if the "wall power" returns at the wrong moment as usual, the "FSD" flag can not be removed from the data server unless its daemon is restarted. If we do take the first step in critical mode, then we intend to go all the way — shut down all the servers gracefully, and power down the UPS.

Keep in mind that some UPS devices and corresponding drivers would latch the "FSD" again even if "wall power" is available, but the remaining battery charge is below a threshold configured as "safe" in the device (usually if you manually power on the UPS after a long power outage). This is by design of respective UPS vendors, since in such situation they can not guarantee that if a new power outage happens, their UPS would safely shut down your systems again. So it is deemed better and safer to stay dark until batteries become sufficiently charged.

(If you have no secondary systems, skip to step 6)

4. `upsmon` secondary systems see "FSD" and:
 - generate a `NOTIFY_SHUTDOWN` event
 - wait `FINALDELAY` seconds — typically 5
 - call their `SHUTDOWNCMD`
 - disconnect from `upsd`
 5. The `upsmon` primary system waits up to `HOSTSYNC` seconds (typically 15) for the secondary systems to disconnect from `upsd`. If any are still connected after this time, `upsmon` primary stops waiting and proceeds with the shutdown process.
 6. The `upsmon` primary:
 - generates a `NOTIFY_SHUTDOWN` event
 - waits `FINALDELAY` seconds — typically 5
 - creates the `POWERDOWNFLAG` file in its local filesystem — usually `/etc/killpower`
 - calls the `SHUTDOWNCMD`
 7. On most systems, `init` takes over, kills your processes, syncs and unmounts some filesystems, and remounts some read-only.
 8. `init` then runs your shutdown script. This checks for the `POWERDOWNFLAG`, finds it, and tells the UPS driver(s) to power off the load by sending commands to the connected UPS device(s) they manage.
 9. All the systems lose power.
 10. Time passes. The power returns, and the UPS switches back on.
 11. All systems reboot and go back to work.
-

6.3.2 How you set it up

NUT user creation

Create a `upsd` user for `upsmon` to use while monitoring this UPS.

Edit `upsd.users` and create a new section. The `upsmon` will connect to `upsd` and use these user name (in brackets) and password to authenticate (as specified in its configuration via `MONITOR` line).

This example is for defining a user called "monuser":

```
[monuser]
    password = mypass
    upsmon primary
    # or upsmon secondary
```

References: [upsd\(8\)](#), [upsd.users\(5\)](#)

Reloading the data server

Reload `upsd`. Depending on your configuration, you may be able to do this without stopping the `upsd` daemon process:

```
upsd -c reload
```

If that doesn't work (check the `syslog`), just restart it:

```
upsd -c stop
upsd
```

For systems with integrated service management (Linux `systemd`, illumos/Solaris `SMF`) their corresponding `reload` or `refresh` service actions should handle this as well.

Note

If you want to make reloading work later, see the entry in the [FAQ](#) about starting `upsd` as a different user.

Power Off flag file

Set the `POWERDOWNFLAG` location for `upsmon`.

In `upsmon.conf`, add a `POWERDOWNFLAG` directive with a filename. The `upsmon` will create this file when the UPS needs to be powered off during a power failure when low battery is reached.

We will test for the presence of this file in a later step.

```
POWERDOWNFLAG /etc/killpower
```

References: man pages: [upsmon\(8\)](#), [upsmon.conf\(5\)](#)

Securing `upsmon.conf`

The recommended setting is to have it owned by `root:nut`, then make it readable by the group and not by the world. This file contains passwords that could be used by an attacker to start a shutdown, so keep it secure.

```
chown root:nut upsmon.conf
chmod 0640 upsmon.conf
```

This step has been placed early in the process so you secure this file before adding sensitive data in the next step.

Create a MONITOR directive for upsmon

Edit *upsmon.conf* and create a `MONITOR` line with the UPS definition (`<upsname>@<hostname>`), username and password from the [NUT user creation](#) step, and the "primary" or "secondary" setting.

If this system is the UPS manager (i.e. it's connected to this UPS directly and can manage it using a suitable NUT driver), its `upsmon` is the primary:

```
MONITOR myupsname@mybox 1 monuser mypass primary
```

If it's just monitoring this UPS over the network, and some other system is the primary, then this one is a secondary:

```
MONITOR myupsname@mybox 1 monuser mypass secondary
```

The number `1` here is the "power value". This should always be set to `1`, unless you have a very special (read: expensive) system with redundant power supplies. In such cases, refer to the User Manual:

- [typical setups for big servers](#),
- [typical setups for data rooms](#).

Note that the "power value" may also be `0` for a monitoring (administrative) system which only observes the remote UPS status but is not impacted by its power events, and so does not shut down when the UPS does.

References: [upsmon\(8\)](#), [upsmon.conf\(5\)](#)

Define a SHUTDOWNCMD for upsmon

Still in *upsmon.conf*, add a directive that tells `upsmon` how to shut down your system. This example seems to work on most systems:

```
SHUTDOWNCMD "/sbin/shutdown -h +0"
```

Notice the presence of "quotes" here to keep it together.

If your system has special needs (e.g. system-provided shutdown handler is ungracefully time constrained), you may want to set this to a script which does customized local shutdown tasks before calling `init` or `shutdown` programs to handle the system side of this operation.

Start upsmon

```
upsmon
```

If it complains about something, then check your configuration.

On operating systems with service management frameworks, the monitoring client life-cycle is managed by `nut-monitor` service.

Checking upsmon

Look for messages in the `syslog` to indicate success. It should look something like this:

```
May 29 01:11:27 mybox upsmon[102]: Startup successful
May 29 01:11:28 mybox upsd[100]: Client monuser@192.168.50.1
logged into UPS [myupsname]
```

Any errors seen here are probably due to an error in the config files of either `upsmon` or `upsd`. You should fix them before continuing.

Startup scripts

Note

This step is not need if you installed from packages.

Edit your startup scripts, and add a call to `upsmon`.

Make sure `upsmon` starts when your system comes up. On systems with `upsmon primary` (also running the data server), do it after `upsdrvctl` and `upsd`, or it will complain about not being able to contact the server.

You may delete the `POWERDOWNFLAG` in the startup scripts, but it is not necessary. `upsmon` will clear that file for you when it starts.

Note

Init script examples are provide in the `scripts` directory of the NUT source tree, and in the various [packages](#) that exist.

Shutdown scripts

Note

This step is not need if you installed from packages.

Edit your shutdown scripts, and add `upsdrvctl shutdown`.

You should configure your system to power down the UPS after the filesystems are remounted read-only. Have it look for the presence of the `POWERDOWNFLAG` (from [upsmon.conf\(5\)](#)), using this as an example:

```
if (/sbin/upsmon -K)
then
    echo "Killing the power, bye!"
    /sbin/upsdrvctl shutdown

    sleep 120

    # uh oh... the UPS power-off failed
    # you probably want to reboot here so you don't get stuck!
    # *** see also the section on power races in the FAQ! ***
fi
```

Warning



- Be careful that `upsdrvctl shutdown` command will probably power off your machine and others fed by the UPS(es) which it manages. Don't use it unless your system is ready to be halted by force. If you run RAID, read the [RAID warning](#) below!
 - Make sure the filesystem(s) containing `upsdrvctl`, `upsmon`, the `POWERDOWNFLAG` file, `ups.conf` and your UPS driver(s) are mounted (possibly in read-only mode) when the system gets to this point. Otherwise it won't be able to figure out what to do.
 - If for some reason you can not ensure `upsmon` program is executable at this point, your script can (`test -f /etc/killpower`) in a somewhat non-portable manner, instead of asking `upsmon -K` for the verdict according to its current configuration.
-

Testing shutdowns

UPS equipment varies from manufacturer to manufacturer and even within model lines. You should test the [shutdown sequence](#) on your systems before leaving them unattended. A successful sequence is one where the OS halts before the battery runs out, and the system restarts when power returns.

The first step is to see how `upsdrvctl` will behave without actually turning off the power. To do so, use the `-t` argument:

```
upsdrvctl -t shutdown
```

It will display the sequence without actually calling the drivers.

You can finally test a forced shutdown sequence (FSD) using:

```
upsmon -c fsd
```

This will execute a full shutdown sequence, as presented in [Shutdown design](#), starting from the 3rd step.

If everything works correctly, the computer will be forcibly powered off, may remain off for a few seconds to a few minutes (depending on the driver and UPS type), then will power on again.

If your UPS just sits there and never resets the load, you are vulnerable to a power race and should add the "reboot after timeout" hack at the very least.

Also refer to the section on power races in the [FAQ](#).

6.3.3 Using suspend to disk

Support for suspend to RAM and suspend to disk has been available in the Linux kernel for a while now. For obvious reasons, suspending to RAM isn't particularly useful when the UPS battery is getting low, but suspend to disk may be an interesting concept.

This approach minimizes the amount of disruption which would be caused by an extended outage. The UPS goes on battery, then reaches low battery, and the system takes a snapshot of itself and halts. Then it is turned off and waits for the power to return.

Once the power is back, the system reboots, pulls the snapshot back in, and keeps going from there. If the user happened to be away when it happened, they may return and have no idea that their system actually shut down completely in the middle (although network connections will drop).

In order for this to work, you need to shutdown NUT (UPS driver, `upsd` server and `upsmon` client) in the `suspend` script and start them again in the `resume` script. Don't try to keep them running. The `upsd` server will latch the FSD state (so it won't be usable after resuming) and so will the `upsmon` client. Some drivers may work after resuming, but many don't and some UPS devices will require re-initialization, so it's best not to keep them running either.

After stopping NUT driver, server and client you'll have to send the UPS the command to shutdown only if the `POWERDOWNFLAG` is present. Note that most likely you'll have to allow for a grace period after calling `upsdrvctl shutdown` since the system will still have to take a snapshot of itself after that. Not all drivers and devices support this, so before going down this road, make sure that the one you're using does.

- see if you can query or configure settings named like `load.off.delay`, `ups.delay.shutdown`, `offdelay` and/or `shutdown_delay`

6.3.4 RAID warning

If you run any sort of RAID equipment, make sure your arrays are either halted (if possible) or switched to "read-only" mode. Otherwise you may suffer a long resync once the system comes back up.

The kernel may not ever run its final shutdown procedure, so you must take care of all array shutdowns in userspace before `upsdrvctl shutdown` runs.

If you use software RAID (md) on Linux, get `mdadm` and try using `mdadm --readonly` to put your arrays in a safe state. This has to happen after your shutdown scripts have remounted the filesystems.

On hardware RAID or other kernels, you have to do some detective work. It may be necessary to contact the vendor or the author of your driver to find out how to put the array in a state where a power loss won't leave it "dirty".

Our understanding is that most if not all RAID devices on Linux will be fine unless there are pending writes. Make sure your filesystems are remounted read-only and you should be covered.

6.4 Typical setups for enterprise networks and data rooms

The split nature of this UPS monitoring software allows a wide variety of power connections. This chapter will help you identify how things should be configured using some general descriptions.

There are two main elements:

1. There's a UPS attached to a communication (serial, USB or network) port on this system.
2. This system depends on a UPS for power.

You can play "mix and match" with those two to arrive at these descriptions for individual hosts:

- A: 1 but not 2
- B: 2 but not 1
- C: 1 and 2

A small to medium sized data room usually has one *C* and a bunch of *Bs*. This means that there's a system (type *C*) hooked to the UPS which depends on it for power. There are also some other systems in there (type *B*) which depend on that same UPS for power, but aren't directly connected to it communications-wise.

Larger data rooms or those with multiple UPSes may have several "clusters" of the "single *C*, many *Bs*" depending on how it's all wired.

Finally, there's a special case. Type *A* systems are connected to an UPS's communication port, but don't depend on it for power. This usually happens when an UPS is physically close to a box and can reach the serial port, but the power wiring is such that it doesn't actually feed that box.

Once you identify a system's type, use this list to decide which of the programs need to be run for monitoring:

- A: driver and `upsd`
 - B: `upsmon` (in secondary mode)
 - C: driver, `upsd`, and `upsmon` (in primary mode, as the UPS manager)
-

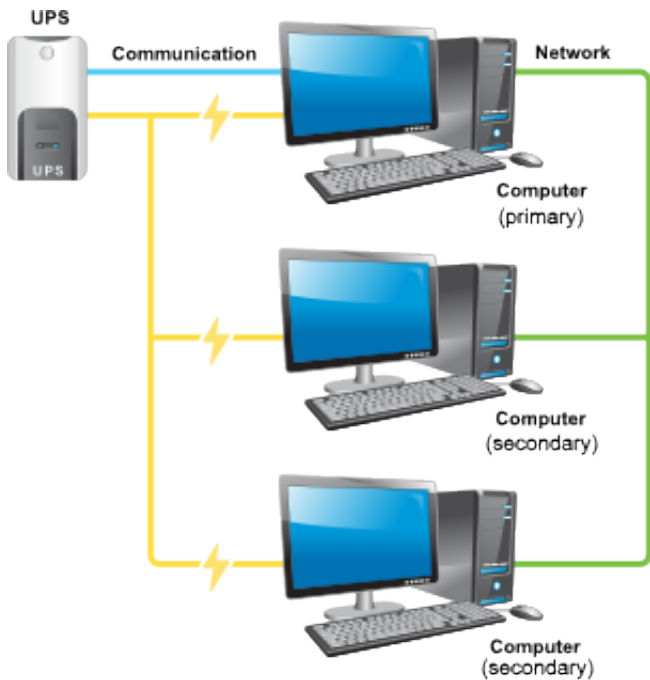

To further complicate things, you can have a system that is hooked to multiple UPSes, but only depends on one for power. This particular situation makes it an A relative to one UPS, and a C relative to the other. The software can handle this — you just have to tell it what to do.

Note

NUT can also serve as a data proxy to increase the number of clients, or share the communication load between several `upsd` instances.

If you are running large server-class systems that have more than one power feed, see the next section for information on how to handle it properly.

6.5 Typical setups for big servers with UPS redundancy

By using multiple `MONITOR` statements in `upsmon.conf`, you can configure an environment where a large machine with redundant power monitors multiple separate UPSes.

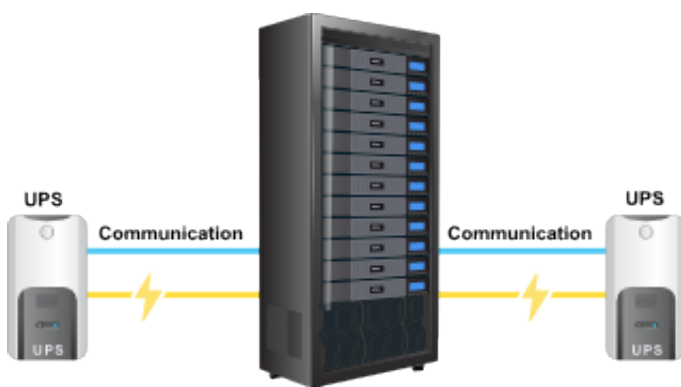

6.5.1 Example configuration

For the examples in this section, we will use a server with four power supplies installed and locally running the full NUT stack, including `upsmon` in primary mode — as the UPS manager.

Two UPSes, *Alpha* and *Beta*, are each driving two of the power supplies (by adding up, we know about the four power supplies of the current system). This means that either *Alpha* or *Beta* can totally shut down and the server will be able to keep running.

The *upsmon.conf* configuration which reflects this is the following:

```
MONITOR ups-alpha@myhost 2 monuser mypass primary
MONITOR ups-beta@myhost 2 monuser mypass primary
MINSUPPLIES 2
```

With such configuration, *upsmon* on this system will only shut down when both UPS devices reach a critical (on battery + low battery) condition, since *Alpha* and *Beta* each provide the same power value.

As an added bonus, this means you can move a running server from one UPS to another (for maintenance purpose for example) without bringing it down since the minimum sufficient power will be provided at all times.

The *MINSUPPLIES* line tells *upsmon* that we need at least 2 power supplies to be receiving power from a good UPS (on line or on battery, just not on battery **and** low battery).

Note

We could have used a *Power Value* of 1 for both UPS, and have *MINSUPPLIES* set to 1 too. These values are purely arbitrary, so you are free to use your own rules. Here, we have linked these values to the number of power supplies that each UPS is feeding (2) since this maps better to physical topology and allows to throw a third or fourth UPS into the mix without much configuration headache.

6.5.2 Multiple UPS shutdowns ordering

If you have multiple UPSes connected to your system, chances are that you need to shut them down in a specific order. The goal is to shut down everything but the one keeping *upsmon* alive at first, then you do that one last.

To set the order in which your UPSes receive the shutdown commands, define the *sdorder* value in your *ups.conf* device sections.

```
[bigone]
    driver = usbhid-ups
    port = auto
    sdorder = 2

[littleguy]
    driver = mge-shut
    port = /dev/ttyS0
    sdorder = 1

[misc]
    driver = blazer_ser
    port = /dev/ttyS1
    sdorder = 0
```

The order runs from 0 to the highest number available. So, for this configuration, the order of shutdowns would be *misc*, *littleguy*, and then *bigone*.

Note

If you have a UPS that shouldn't be powered off when running *upsdrvctl shutdown*, set its *sdorder* to -1.

6.5.3 Other redundancy configurations

There are a lot of ways to handle redundancy and they all come down to how many power supplies, power cords and independent UPS connections you have. A system with a 1:1 cord:supply ratio has more wires stuffed behind it, but it's much easier to move things around since any given UPS drives a smaller percentage of the overall power.

More information can be found in the [NUT user manual](#), and the various [user manual pages](#).

7 Advanced usage and scheduling notes

Two NUT websites

This version of the page reflects NUT release *v2.8.0* with codebase committed *ff16dabca* at *2022-04-04T11:04:28+00:00*. Options, features and capabilities in current development (and future releases) are detailed on the main site and may differ from ones described here.

upsmon can call out to a helper script or program when the device changes state. The example `upsmon.conf` has a full list of which state changes are available — `ONLINE`, `ONBATT`, `LOWBATT`, and more.

There are two options, that will be presented in details:

- the simple approach: create your own helper, and manage all events and actions yourself,
- the advanced approach: use the NUT provided helper, called *upssched*.

7.1 The simple approach, using your own script

7.1.1 How it works relative to upsmon

Your command will be called with the full text of the message as one argument.

For the default values, refer to the sample `upsmon.conf` file.

The environment string `NOTIFYTYPE` will contain the type string of whatever caused this event to happen — `ONLINE`, `ONBATT`, `LOWBATT`, ...

Making this some sort of shell script might be a good idea, but the helper can be in any programming or scripting language.

Note

Remember that your helper must be **executable**. If you are using a script, make sure the execution flags are set.

For more information, refer to [upsmon\(8\)](#) and [upsmon.conf\(5\)](#) manual pages.

7.1.2 Setting up everything

- Set `EXEC` flags on various things in [upsmon.conf\(5\)](#):

```
NOTIFYFLAG ONBATT EXEC
NOTIFYFLAG ONLINE EXEC
```

If you want other things like `WALL` or `SYSLOG` to happen, just add them:

```
NOTIFYFLAG ONBATT EXEC+WALL+SYSLOG
```

You get the idea.

- Tell upsmon where your script is

```
NOTIFYCMD /path/to/my/script
```

- Make a simple script like this at that location:

```
#!/bin/bash
echo "$*" | sendmail -F"ups@mybox" bofh@pager.example.com
```

- Restart upsmon, pull the plug, and see what happens.

That approach is bare-bones, but you should get the text content of the alert in the body of the message, since upsmon passes the alert text (from NOTIFYMSG) as an argument.

7.1.3 Using more advanced features

Your helper script will be run with a few environment variables set.

- UPSNAME: the name of the system that generated the change.
This will be one of your identifiers from the MONITOR lines in upsmon.conf.
- NOTIFYTYPE: this will be ONLINE, ONBATT, or whatever event took place which made upsmon call your script.

You can use these to do different things based on which system has changed state. You could have it only send pages for an important system while totally ignoring a known trouble spot, for example.

7.1.4 Suppressing notify storms

upsmon will call your script every time an event happens that has the EXEC flag set. This means a quick power failure that lasts mere seconds might generate a notification storm. To suppress this sort of annoyance, use upssched as your NOTIFYCMD program, and configure it to call your command after a timer has elapsed.

7.2 The advanced approach, using upssched

upssched is a helper for upsmon that will invoke commands for you at some interval relative to a UPS event. It can be used to send pages, mail out notices about things, or even shut down the box early.

There will be examples scattered throughout. Change them to suit your pathnames, UPS locations, and so forth.

7.2.1 How upssched works relative to upsmon

When an event occurs, upsmon will call whatever you specify as a *NOTIFYCMD* in your upsmon.conf, if you also enable the *EXEC* in your *NOTIFYFLAGS*. In this case, we want upsmon to call upssched as the notifier, since it will be doing all the work for us. So, in the upsmon.conf:

```
NOTIFYCMD /usr/local/ups/sbin/upssched
```

Then we want upsmon to actually *use* it for the notify events, so again in the upsmon.conf we set the flags:

```
NOTIFYFLAG ONLINE SYSLOG+EXEC
NOTIFYFLAG ONBATT SYSLOG+WALL+EXEC
NOTIFYFLAG LOWBATT SYSLOG+WALL+EXEC
... and so on.
```

For the purposes of this document I will only use those three, but you can set the flags for any of the valid notify types.

7.2.2 Setting up your upssched.conf

Once upsmoN has been configured with the NOTIFYCMD and EXEC flags, you're ready to deal with the upssched.conf details. In this file, you specify just what will happen when a given event occurs on a particular UPS.

First you need to define the name of the script or program that will handle timers that trigger. This is your CMDSCRIPT, and needs to be above any AT defines. There's an example provided with the program, so we'll use that here:

```
CMDSCRIPT /usr/local/ups/bin/upssched-cmd
```

Then you have to define the variables PIPEFN and LOCKFN; the former sets the file name of the FIFO that will pass communications between processes to start and stop timers, while the latter sets the file name for a temporary file created by upssched in order to avoid a race condition under some circumstances. Please see the relevant comments in upssched.conf for additional information and advice about these variables.

Now you can tell your CMDSCRIPT what to do when it is called by upsmoN.

The big picture

The design in a nutshell is:

```
upsmoN ---> calls upssched ---> calls your CMDSCRIPT
```

Ultimately, the CMDSCRIPT does the actual useful work, whether that's initiating an early shutdown with *upsmoN -c fsd*, sending a page by calling sendmail, or opening a subspace channel to V'ger.

Establishing timers

Let's say that you want to receive a notification when any UPS has been running on battery for 30 seconds. Create a handler that starts a 30 second timer for an ONBATT condition.

```
AT ONBATT * START-TIMER onbattwarn 30
```

This means "when any UPS (the *) goes on battery, start a timer called onbattwarn that will trigger in 30 seconds". We'll come back to the onbattwarn part in a moment. Right now we need to make sure that we don't trigger that timer if the UPS happens to come back before the time is up. In essence, if it goes back on line, we need to cancel it. So, let's tell upssched that.

```
AT ONLINE * CANCEL-TIMER onbattwarn
```

Note

Timers are pure in-memory mechanisms, specific to upssched. Conversely to other mechanisms found in NUT, such as upsmoN→POWERDOWNFLAG, there is no file created on the filesystem.

Executing commands immediately

As an example, consider the scenario where a UPS goes onto battery power. However, the users are not informed until 60 seconds later—using a timer as described above. Whilst this may let the **logged in** users know that the UPS is on battery power, it does not inform any users subsequently logging in. To enable this we could, at the same time, create a file which is read and displayed to any user trying to login whilst the UPS is on battery power. If the UPS comes back onto utility power within 60 seconds, then we can cancel the timer and remove the file, as described above. However, if the UPS comes back onto utility power say 5 minutes later then we do not want to use any timers but we still want to remove the file. To do this we could use:

```
AT ONLINE * EXECUTE ups-back-on-power
```

This means that when upsmoN detects that the UPS is back on utility power it will signal upssched. Upssched will see the above command and simply pass *ups-back-on-power* as an argument directly to CMDSCRIPT. This occurs immediately, there are no timers involved.

7.2.3 Writing the command script handler

OK, now that upssched knows how the timers are supposed to work, let's give it something to do when one actually triggers. The name of the example timer is `onbattwarn`, so that's the argument that will be passed into your CMDSCRIPT when it triggers. This means we need to do some shell script writing to deal with that input.

```
#!/bin/sh

case $1 in
    onbattwarn)
        # Send a notification mail
        echo "The UPS has been on battery for awhile" \
        | mail -s"UPS monitor" bofh@pager.example.com
        # Create a flag-file on the filesystem, for your own processing
        /usr/bin/touch /some/path/ups-on-battery
        ;;
    ups-back-on-power)
        # Delete the flag-file on the filesystem
        /bin/rm -f /some/path/ups-on-battery
        ;;
    *)
        logger -t upssched-cmd "Unrecognized command: $1"
        ;;
esac
```

This is a very simple script example, but it shows how you can test for the presence of a given trigger. With multiple ATs creating various timer names, you will need to test for each possibility and handle it according to your desires.

Note

You can invoke just about anything from inside the CMDSCRIPT. It doesn't need to be a shell script, either—that's just an example. If you want to write a program that will parse `argv[1]` and deal with the possibilities, that will work too.

7.2.4 Early Shutdowns

One thing that gets requested a lot is early shutdowns in `upsmon`. With `upssched`, you can now have this functionality. Just set a timer for some length of time at `ONBATT` which will invoke a shutdown command if it elapses. Just be sure to cancel this timer if you go back `ONLINE` before then.

The best way to do this is to use the `upsmon` callback feature. You can make `upsmon` set the "forced shutdown" (FSD) flag on the `upsd` so your secondary systems shut down early too. Just do something like this in your CMDSCRIPT:

```
/sbin/upsmon -c fsd
```

Note

the path to `upsmon` must be provided. The default for an installation built from sources is `/usr/local/ups` (so `/usr/local/ups/sbin/upsmon`), while packaged installations will generally comply to [FHS—Filesystem Hierarchy Standard](#) (so `/sbin/upsmon`).

It's not a good idea to call your system's shutdown routine directly from the CMDSCRIPT, since there's no synchronization with the secondary systems hooked to the same UPS. FSD is the primary's way of saying "we're shutting down **now** like it or not, so you'd better get ready".

7.2.5 Background

This program was written primarily to fulfill the requests of users for the early shutdown scenario. The "outboard" design of the program (relative to upsmon) was intended to reduce the load on the average system. Most people don't have the requirement of shutting down after n seconds on battery, since the usual OB+LB testing is sufficient.

This program was created separately so those people don't have to spend CPU time and RAM on something that will never be used in their environments.

The design of the timer handler is also geared towards minimizing impact. It will come and go from the process list as necessary. When a new timer is started, a process will be forked to actually watch the clock and eventually start the CMDSCRIPT. When a timer triggers, it is removed from the queue. Canceling a timer will also remove it from the queue. When no timers are present in the queue, the background process exits.

This means that you will only see upssched running when one of two things is happening:

1. There's a timer of some sort currently running
2. upsmon just called it, and you managed to catch the brief instance

The final optimization handles the possibility of trying to cancel a timer when there's none running. If there's no process already running, there are no timers to cancel, and furthermore there is no need to start a clock-watcher. As a result, it skips that step and exits sooner.

8 NUT outlets management and PDU notes

Two NUT websites

This version of the page reflects NUT release *v2.8.0* with codebase committed ff16dabca at 2022-04-04T11:04:28+00:00. Options, features and capabilities in current development (and future releases) are detailed on the main site and may differ from ones described here.

NUT supports advanced outlets management for any kind of device that proposes it. This chapter introduces how to manage outlets in general, and how to take advantage of the provided features.

8.1 Introduction

Outlets are the core of Power Distribution Units. They allow you to turn on, turn off or cycle the load on each outlet.

Some UPS models also provide manageable outlets (Eaton, MGE, Powerware, Tripplite, ...) that help save power in various ways, and manage loads more intelligently.

Finally, some devices can be managed in a PDU-like way. Consider blade systems: the blade chassis can be controlled remotely to turn on, turn off or cycle the power on individual blade servers.

NUT allows you to control all these devices!

8.2 NUT outlet data collection

NUT provides a complete and uniform integration of outlets related data, through the *outlet* collection.

First, there is a special outlet, called *main outlet*. You can access it through *outlet.{id, desc, ...}* without any index.

Any modification through the *main outlet* will affect **all** outlets. For example, calling the command *outlet.load.cycle* will cycle all outlets.

Next, outlets index starts from **1**. Index *0* is implicitly reserved to the *main outlet*. So the first outlet is *outlet.1.**.

For a complete list of outlet data and commands, refer to the [NUT command and variable naming scheme](#).

An example upsc output (data/epdu-managed.dev) is available in the source archive.

Note

The variables supported depend on the exact device type.

8.3 Outlets on PDU

Smart Power Distribution Units provide at least various meters, related to current, power and voltage.

Some more advanced devices also provide control through the *load.off*, *load.on* and *load.cycle* commands.

8.4 Outlets on UPS

Some advanced Uninterruptible Power Supplies provide smart outlet management.

This allows to program a limited backup time to non-critical loads in order to keep the maximum of the battery reserve for critical equipment.

This also allows the same remote electrical management of devices provided by PDUs, which can be very interesting in Data Centers.

For example, on small setup, you can plug printers, USB devices, hubs, (...) into managed outlets. Depending on your UPS's capabilities, you will be able to turn off those loads:

- after some minutes of back-up time using *outlet.n.delay.start*,
- when reaching a percentage battery charge using *outlet.n.autoswitch.charge.low*.

This will ensure a maximum runtime for the computer.

On bigger systems, with bigger UPSs, this is the same thing with servers instead of small devices.

Note

If you need the scheduling function and your device doesn't support it, you can still use [NUT scheduling features](#).

**Warning**

don't plug the UPS's communication cable (USB or network) on a managed outlet. Otherwise, all computers will be stopped as soon as the communication is lost.

8.5 Other type of devices

As mentioned in the introduction, some other devices can be considered and managed like PDUs. This is the case in most blade systems, where the blade chassis offers power management services.

This way, you can control remotely each blade server as if it were a PDU outlet.

This category of devices is generally called Remote Power Controls — or "RPC" in NUT.

9 NUT daisychain support notes

Two NUT websites

This version of the page reflects NUT release *v2.8.0* with codebase committed *ff16dabca* at *2022-04-04T11:04:28+00:00*. Options, features and capabilities in current development (and future releases) are detailed on the main site and may differ from ones described here.

NUT supports daisy-chained devices for any kind of device that proposes it. This chapter introduces:

- for developers: how to implement such mechanism,
- for users: how to manage and use daisy-chained devices in NUT in general, and how to take advantage of the provided features.

9.1 Introduction

It's not unusual to see some daisy-chained PDUs or UPSs, connected together in master-slave mode, to only consume 1 IP address for their communication interface (generally, network card exposing SNMP data) and expose only one point of communication to manage several devices, through the daisy-chain master.

This breaks the historical consideration of NUT that one driver provides data for one unique device. However, there is an actual need, and a smart approach was considered to fulfill this, while not breaking the standard scope (for base compatibility).

9.2 Implementation notes

9.2.1 General specification

The daisychain support uses the device collection to extend the historical NUT scope (1 driver — 1 device), and provides data from the additional devices accessible through a single management interface.

A new variable was introduced to provide the number of devices exposed: the `device.count`, which:

- defaults to 1
- if higher than 1, enables daisychain support and access to data of each individual device through `device.X.{...}`

To ensure backward compatibility in NUT, the data of the various devices are exposed the following way:

- `device.0` is a special case, for the whole set of devices (the whole daisychain). It is equivalent to `device` (without `.X` index) and root collections. The idea is to be able to get visibility and control over the whole daisychain from a single point.
- daisy-chained devices are available from `device.1` (master) to `device.N` (slaves).

That way, client applications that are unaware of the daisychain support, will only see the whole daisychain, as it would normally seem, and not nothing at all.

Moreover, this solution is generic, and not specific to the ePDU use case currently considered. It thus support both the current NUT scope, along with other use cases (parallel / serial UPS setups), and potential evolution and technology change (hybrid chain with UPS and PDU for example).

Devices status handling

To be clarified...

Devices alarms handling

Devices (master and slaves) alarms are published in `device.X.ups.alarm`, which may evolve into `device.X.alarm`. If any of the devices has an alarm, the main `ups.status` will publish an ALARM flag. This flag is be cleared once all devices have no alarms anymore.

Note

`ups.alarm` behavior is not yet defined (all devices alarms vs. list of device(s) that have alarms vs. nothing?)

Example

Here is an example excerpt of three PDUs, connected in daisychain mode, with one master and two slaves:

```
device.count: 3
device.mfr: EATON
device.model: EATON daisychain PDU
device.1.mfr: EATON
device.1.model: EPDU MI 38U-A IN: L6-30P 24A 1P OUT: 36XC13:6XC19
device.2.mfr: EATON
device.2.model: EPDU MI 38U-A IN: L6-30P 24A 1P OUT: 36XC13:6XC19
device.3.mfr: EATON
device.3.model: EPDU MI 38U-A IN: L6-30P 24A 1P OUT: 36XC13:6XC19
...
device.3.ups.alarm: high current critical!
device.3.ups.status: ALARM
...
input.voltage: ??? (proposal: range or list or average?)
device.1.input.voltage: 237.75
device.2.input.voltage: 237.75
device.3.input.voltage: 237.75
...
outlet.1.status: ?? (proposal: "on, off, off)
device.1.outlet.1.status: on
device.2.outlet.1.status: off
device.3.outlet.1.status: off
...
ups.status: ALARM
```

9.2.2 Information for developers**Note**

these details are dedicated to the `snmp-ups` driver!

In order to enable daisychain support for a range of devices, developers have to do two things:

- Add a `device.count` entry in a mapping file (see `*-mib.c`)
- Modify mapping entries to include a format string for the daisychain index

Optionally, if there is support for outlets and / or outlet-groups, there is already a template formatting string. So you have to tag such templates with multiple definitions, to point if the daisychain index is the first or second formatting string.

Base support

In order to enable daisychain support on a mapping structure, the following steps have to be done:

- Add a "device.count" entry in the mapping file: `snmp-ups` will determine if the daisychain support has to be enabled (if more than 1 device). To achieve this, use one of the following type of declarations:

a) point at an OID which provides the number of devices:

```
{ "device.count", 0, 1, ".1.3.6.1.4.1.13742.6.3.1.0", "1",
  SU_FLAG_STATIC, NULL },
```

b) point at a template OID to guesstimate the number of devices, by walking through this template, until it fails:

```
{ "device.count", 0, 1, ".1.3.6.1.4.1.534.6.6.7.1.2.1.2.%i", "1",
  SU_FLAG_STATIC, NULL, NULL },
```

- Modify all entries so that OIDs include the formatting string for the daisychain index. For example, if you have the following entry:

```
{ "device.model", ST_FLAG_STRING, SU_INFOSIZE,
  ".1.3.6.1.4.1.534.6.6.7.1.2.1.2.0", ... },
```

And if the last "0" of the the 4th field represents the index of the device in the daisychain, then you would have to adapt it the following way:

```
{ "device.model", ST_FLAG_STRING, SU_INFOSIZE,
  ".1.3.6.1.4.1.534.6.6.7.1.2.1.2.%i", ... },
```

Templates with multiple definitions

If there already exist templates in the mapping structure, such as for single outlets and outlet-groups, you also need to specify the position of the daisychain device index in the OID strings for all entries in the mapping table, to indicate where the daisychain insertion point is exactly.

For example, using the following entry:

```
{ "outlet.%i.current", 0, 0.001, ".1.3.6.1.4.1.534.6.6.7.6.4.1.3.0.%i",
  NULL, SU_OUTLET, NULL, NULL },
```

You would have to translate it to:

```
{ "outlet.%i.current", 0, 0.001, ".1.3.6.1.4.1.534.6.6.7.6.4.1.3.%i.%i",
  NULL, SU_OUTLET | SU_TYPE_DAISSY_1, NULL, NULL },
```

SU_TYPE_DAISSY_1 flag indicates that the daisychain index is the first %i specifier in the OID template string. If it is the second one, use SU_TYPE_DAISSY_2.

Devices alarms handling

Two functions are available to handle alarms on daisychain devices in your driver:

- `device_alarm_init()`: clear the current alarm buffer
- `device_alarm_commit(const int device_number)`: commit the current alarm buffer to "device.<device_number>.ups." and increase the count of alarms. If the current alarms buffer is empty, the count of alarm is decreased, and the variable "device.<device_number>.ups.alarm" is removed from publication. Once the alarm count reaches "0", the main (device.0) ups.status will also remove the "ALARM" flag.

Note

When implementing a new driver, the following functions have to be called:

- `alarm_init()` at the beginning of the main update loop, for the whole daisychain. This will set the alarm count to "0", and reinitialize all alarms,
 - `device_alarm_init()` at the beginning of the per-device update loop. This will only clear the alarms for the current device,
 - `device_alarm_commit()` at the end of the per-device update loop. This will flush the current alarms for the current device,
 - also `device_alarm_init()` at the end of the per-device update loop. This will clear the current alarms, and ensure that this buffer will not be considered by other subsequent devices,
 - `alarm_commit()` at the end of the main update loop, for the whole daisychain. This will take care of publishing or not the "ALARM" flag in the main `ups.status(device.0, root collection)`.
-

10 Notes on securing NUT

Two NUT websites

This version of the page reflects NUT release *v2.8.0* with codebase committed `ff16dabca` at `2022-04-04T11:04:28+00:00`. Options, features and capabilities in current development (and future releases) are detailed on the main site and may differ from ones described here.

The NUT Team is very interested in providing the highest security level to its users.

Many internal and external mechanisms exist to secure NUT. And several steps are needed to ensure that your NUT setup meets your security requirements.

This chapter will present you these mechanisms, by increasing order of security level. This means that the more security you need, the more mechanisms you will have to apply.

Note

you may want to have a look at NUT Quality Assurance, since some topics are related to NUT security and reliability.

10.1 How to verify the NUT source code signature

In order to verify the NUT source code signature for releases, perform the following steps:

- Retrieve the **NUT source code** (`nut-X.Y.Z.tar.gz`) and the matching signature (`nut-X.Y.Z.tar.gz.sig`)
- Retrieve the **NUT maintainer's signature**:

```
$ gpg --fetch-keys http://www.networkupstools.org/source/nut-key.gpg
```

Note

As of NUT 2.7.3, a new release key is used. In order to verify a previous release, please use **NUT old maintainer's signature**

- Launch the GPG checking using the following command:
-

```
$ gpg --verify nut-X.Y.Z.tar.gz.sig
```

- You should see a message mentioning a "Good signature", like:

```
gpg: Signature made Wed Apr 15 15:55:30 2015 CEST using RSA key ID 55CA5976
gpg: Good signature from "Arnaud Quette ..."
...
```

Note

the previously used maintainer's signature would output:

```
+ gpg: Signature made Thu Jul 5 16:15:05 2007 CEST using DSA key ID 204DDF1B gpg: Good signature from "Arnaud Quette ..." ...
```

10.2 System level privileges and ownership

All configuration files should be protected so that the world can't read them. Use the following commands to accomplish this:

```
chown root:nut /etc/nut/*
chmod 640 /etc/nut/*
```

Finally, the [state path](#) directory, which holds the communication between the driver(s) and `upsd`, should also be secured.

```
chown root:nut /var/state/ups
chmod 0770 /var/state/ups
```

10.3 NUT level user privileges

Administrative commands such as setting variables and the instant commands are powerful, and access to them needs to be restricted.

NUT provides an internal mechanism to do so, through [upsd.users\(5\)](#).

This file defines who may access instant commands and settings, and what is available.

During the initial [NUT user creation](#), we have created a monitoring user for `upsmon`.

You can also create an *administrator* user with full power using:

```
[administrator]
    password = mypass
    actions = set
    instcmds = all
```

For more information on how to restrict actions and instant commands, refer to [upsd.users\(5\)](#) manual page.

Note

NUT administrative user definitions should be used in conjunction with [TCP Wrappers](#).

10.4 Network access control

If you are not using NUT on a standalone setup, you will need to enforce network access to `upsd`.

There are various ways to do so.

10.4.1 NUT LISTEN directive

`upsd.conf(5)`.

```
LISTEN interface port
```

Bind a listening port to the interface specified by its Internet address. This may be useful on hosts with multiple interfaces. You should not rely exclusively on this for security, as it can be subverted on many systems.

Listen on TCP port `port` instead of the default value which was compiled into the code. This overrides any value you may have set with `configure --with-port`. If you don't change it with `configure` or this value, `upsd` will listen on port 3493 for this interface.

Multiple LISTEN addresses may be specified. The default is to bind to `127.0.0.1` if no LISTEN addresses are specified (and `::1` if IPv6 support is compiled in).

```
LISTEN 127.0.0.1
LISTEN 192.168.50.1
LISTEN ::1
LISTEN 2001:0db8:1234:08d3:1319:8a2e:0370:7344
```

This parameter will only be read at startup. You'll need to restart (rather than reload) `upsd` to apply any changes made here.

10.4.2 Firewall

NUT has its own official IANA port: 3493/tcp.

The `upsmon` process on secondary systems, as well as any other NUT client (such as `upsc`, `upscmd`, `upsrw`, NUT-Monitor, ...) connects to the `upsd` process on the system which manages the UPS, via this TCP port. Usually an `upsmon` process runs on the latter system in "primary" mode for the devices connected to it.

The `upsd` process does not initiate outgoing connections.

Certain NUT drivers (for network-managed devices) can initiate their own connections to various ports according to corresponding vendor protocol.

You should use this to restrict network access.

Uncomplicated Firewall (UFW) support

NUT can tightly integrate with [Uncomplicated Firewall](#) using the provided profile (`nut.ufw.profile`).

You must first install the profile on your system:

```
$ cp nut.ufw.profile /etc/ufw/applications.d/
```

To enable outside access to your local `upsd`, use:

```
$ ufw allow NUT
```

To restrict access to the network `192.168.X.Y`, use:

```
$ ufw allow from 192.168.0.0/16 to any app NUT
```

You can also use graphical frontends, such as `gui-ufw` (`gufw`), `ufw-kde` or `ufw-frontends`.

For more information, refer to:

- [UFW homepage](#),
- [UFW project page](#),
- [UFW wiki](#),
- UFW manual page, section APPLICATION INTEGRATION

10.4.3 TCP Wrappers

If the server is build with tcp-wrappers support enabled, it will check if the NUT username is allowed to connect from the client address through the `/etc/hosts.allow` and `/etc/hosts.deny` files.

Note

this will only be done for commands that require the user to be logged into the server.

`hosts.allow:`

```
upsd : admin@127.0.0.1/32
upsd : observer@127.0.0.1/32 observer@192.168.1.0/24
```

`hosts.deny:`

```
upsd : ALL
```

Further details are described in `hosts_access(5)`.

10.5 Configuring SSL

SSL is available as a build option (`--with-ssl`).

It encrypts sessions between upsd and clients, and can also be used to authenticate servers.

This means that stealing port 3493 from upsd will no longer net you interesting passwords.

Several things must happen before this will work, however. This chapter will present these steps.

SSL is available via two back-end libraries : NSS and OpenSSL (historically). You can choose to use one of them by specifying it with a build option (`--with-nss` or `--with-openssl`). If neither is specified, the configure script will try to detect one of them, with a precedence for OpenSSL.

10.5.1 OpenSSL backend usage

This section describes how to enable NUT SSL support using [OpenSSL](#).

Install OpenSSL

Install [OpenSSL](#) as usual, either from source or binary packages. If using binary packages, be sure to include the developer libraries.

Recompile and install NUT

Recompile NUT from source, starting with `configure --with-openssl`.

Then install everything as usual.

Create a certificate and key for upsd

`openssl` (the program) should be in your `PATH`, unless you installed it from source yourself, in which case it may be in `/usr/local/ssl/bin`.

Use the following command to create the certificate:

```
openssl req -new -x509 -nodes -out upsd.crt -keyout upsd.key
```

You can also put a `-days nnn` in there to set the expiration. If you skip this, it may default to 30 days. This is probably not what you want.

It will ask several questions. What you put in there doesn't matter a whole lot, since nobody is going to see it for now. Future versions of the clients may present data from it, so you might use this opportunity to identify each server somehow.

Figure out the hash for the key

Use the following command to determine the hash of the certificate:

```
openssl x509 -hash -noout -in upsd.crt
```

You'll get back a single line with 8 hex characters. This is the hash of the certificate, which is used for naming the client-side certificate. For the purposes of this example the hash is **0123abcd**.

Install the client-side certificate

Use the following commands to install the client-side certificate:

```
mkdir <certpath>
chmod 0755 <certpath>
cp upsd.crt <certpath>/<hash>.0
```

Example:

```
mkdir /usr/local/ups/etc/certs
chmod 0755 /usr/local/ups/etc/certs
cp upsd.crt /usr/local/ups/etc/certs/0123abcd.0
```

If you already have a file with that name in there, increment the 0 until you get a unique filename that works.

If you have multiple client systems (like upsmon instances in secondary mode), be sure to install this file on them as well.

We recommend making a directory under your existing confpath to keep everything in the same place. Remember the path you created, since you will need to put it in upsmon.conf later.

It must not be writable by unprivileged users, since someone could insert a new client certificate and fool upsmon into trusting a fake upsd.

Create the combined file for upsd

To do so, use the below commands:

```
cat upsd.crt upsd.key > upsd.pem
chown root:nut upsd.pem
chmod 0640 upsd.pem
```

This file must be kept secure, since anyone possessing it could pretend to be upsd and harvest authentication data if they get a hold of port 3493.

Having it be owned by *root* and readable by group *nut* allows upsd to read the file without being able to change the contents. This is done to minimize the impact if someone should break into upsd. NUT reads the key and certificate files after dropping privileges and forking.

Note on certification authorities (CAs) and signed keys

There are probably other ways to handle this, involving keys which have been signed by a CA you recognize. Contact your local SSL guru.

Install the server-side certificate

Install the certificate with the following command:

```
mv upsd.pem <upsd certfile path>
```

Example:

```
mv upsd.pem /usr/local/ups/etc/upsd.pem
```

After that, edit your `upsd.conf` and tell it where to find it:

```
CERTFILE /usr/local/ups/etc/upsd.pem
```

Clean up the temporary files

```
rm -f upsd.crt upsd.key
```

Restart upsd

It should come back up without any complaints. If it says something about keys or certificates, then you probably missed a step. If you run `upsd` as a separate user id (like `nutsrv`), make sure that user can read the `upsd.pem` file.

Point upsmon at the certificates

Edit your `upsmon.conf`, and tell it where the `CERTPATH` is:

```
CERTPATH <path>
```

Example:

```
CERTPATH /usr/local/ups/etc/certs
```

Recommended: make upsmon verify all connections with certificates

Put this in `upsmon.conf`:

```
CERTVERIFY 1
```

Without this, there is no guarantee that the `upsd` is the right host. Enabling this greatly reduces the risk of man in the middle attacks.

This effectively forces the use of SSL, so don't use this unless all of your `upsd` hosts are ready for SSL and have their certificates in order.

Recommended: force upsmon to use SSL

Again in `upsmon.conf`:

```
FORCESSL 1
```

If you don't use `CERTVERIFY 1`, then this will at least make sure that nobody can sniff your sessions without a large effort. Setting this will make `upsmon` drop connections if the remote `upsd` doesn't support SSL, so don't use it unless all of them have it running.

10.5.2 NSS backend usage

This section describes how to enable NUT SSL support using [Mozilla NSS](#).

Install NSS

Install [Mozilla NSS](#) as usual, either from source or binary packages. If using binary packages, be sure to include the developer libraries, and nss-tools (for `certutil`).

Recompile and install NUT

Recompile NUT from source, starting with `configure --with-nss`.

Then install everything as usual.

Create certificate and key for the host

NSS (package generally called `libnss3-tools`) will install a tool called `certutil`. It will be used to generate certificates and manage certificate database.

Certificates should be signed by a certification authorities (CAs). Following commands are typical samples, contact your SSL guru or security officer to follow your company procedures.

GENERATE A SERVER CERTIFICATE FOR UPSD:

- Create a directory where store the certificate database: `mkdir cert_db`
- Create the certificate database: `certutil -N -d cert_db`
- Import the CA certificate: `certutil -A -d cert_db -n "My Root CA" -t "TC," -a -i rootca.crt`
- Create a server certificate request (here called *My nut server*): `certutil -R -d cert_db -s "CN=My nut server,O=My" -a -o server.req`
- Make your CA sign the certificate (produces `server.crt`)
- Import the signed certificate into server database: `certutil -A -d cert_db -n "My nut server" -a -i server.c -t ","`
- Display the content of certificate server: `certutil -L -d cert_db`

Clients and servers in the same host could share the same certificate to authenticate them or use different ones in same or different databases. The same operation can be done in same or different databases to generate other certificates.

Create a self-signed CA certificate

NSS provides a way to create self-signed certificate which can acting as CA certificate, and to sign other certificates with this CA certificate. This method can be used to provide a CA certification chain without using an "official" certificate authority.

GENERATE A SELF-SIGNED CA CERTIFICATE:

- Create a directory where store the CA certificate database: `mkdir CA_db`
- Create the certificate database: `certutil -N -d CA_db`
- Generate a certificate for CA: `certutil -S -d CA_db -n "My Root CA" -s "CN=My CA,O=MyCompany,ST=MySt" -t "CT," -x -2` (Do not forget to answer *Yes* to the question *Is this a CA certificate [y/N]?*)
- Extract the CA certificate to be able to import it in upsd (or upsmon) certificate database: `certutil -L -d CA_db -n "My Root CA" -a -o rootca.crt`
- Sign a certificate request with the CA certificate (simulate a real CA signature): `certutil -C -d CA_db -c "My Root CA" -a -i server.req -o server.crt -2 -6`

Install the server-side certificate

Just copy the database directory (just the directory and included 3 database .db files) to the right place, such as `/usr/local/ups/etc`

```
mv cert_db /usr/local/ups/etc/
```

upsd (required): certificate database and self certificate

Edit the `upsd.conf` to tell where find the certificate database:

```
CERTPATH /usr/local/ups/etc/cert_db
```

Also tell which is the certificate to send to clients to authenticate itself and the password to decrypt private key associated to certificate:

```
CERTIDENT 'certificate name' 'database password'
```

Note

Generally, the certificate name is the server domain name, but is not a hard rule. The certificate can be named as useful.

upsd (optional): client authentication

Note

This functionality is disabled by default. To activate it, recompile NUT with `WITH_CLIENT_CERTIFICATE_VALIDATION` defined:

```
make CFLAGS="-DWITH_CLIENT_CERTIFICATE_VALIDATION"
```

UPSD can accept three levels of client authentication. Just specify it with the directive `CERTREQUEST` with the corresponding value in the `upsd.conf` file:

- **NO**: no client authentication.
- **REQUEST**: a certificate is request to the client but it is not strictly validated. If the client does not send any certificate, the connection is closed.
- **REQUIRE**: a certificate is requested to the client and if it is not valid (no validation chain) the connection is closed.

Like CA certificates, you can add many *trusted* client and CA certificates in server's certificate databases.

upsmon (required): upsd authentication

In order for `upsmon` to securely connect to `upsd`, it must authenticate it. You must associate an `upsd` host name to security rules in `upsmon.conf` with the directive `CERTHOST`.

`CERTHOST` associates a hostname to a certificate name. It also determines whether a SSL connection is mandatory, and if the server certificate must be validated.

```
CERTHOST 'hostname' 'certificate name' 'certverify' 'forcessl'
```

If the flag `forcessl` is set to 1, and `upsd` answers that it can not connect with SSL, the connection closes. If the flag `certverify` is set to 1 and the connection is done in SSL, `upsd`'s certificate is verified and its name must be the specified *certificate name*.

To prevent security leaks, you should set all `certverify` and `forcessl` flags to 1 (force SSL connection and validate all certificates for all peers).

You can specify `CERTVERIFY` and `FORCESSL` directive (to 1 or 0) to define a default security rule to apply to all host not specified with a dedicated `CERTHOST` directive.

If a host is not specified in a `CERTHOST` directive, its expected certificate name is its hostname.

upsmon (optional): certificate database and self certificate

Like `upsd`, `upsmon` may need to authenticate itself (`upsd`'s `CERTREQUEST` directive set to `REQUEST` or `REQUIRE`). It must access to a certificate (and its private key) in a certificate database configuring `CERTPATH` and `CERTIDENT` in `upsmon.conf` in the same way as `upsd`.

```
CERTPATH /usr/local/ups/etc/cert_db
CERTIDENT 'certificate name' 'database password'
```

10.5.3 Restart upsd

It should come back up without any complaints. If it says something about keys or certificates, then you probably missed a step.

If you run `upsd` as a separate user ID (like `nutsrv`), make sure that user can read files in the certificate directory. NUT reads the keys and certificates after forking and dropping privileges.

10.5.4 Restart upsmon

You should see something like this in the syslog from `upsd`:

```
foo upsd[1234]: Client mon@localhost logged in to UPS [myups] (SSL)
```

If `upsd` or `upsmon` give any error messages, or the `(SSL)` is missing, then something isn't right.

If in doubt about `upsmon`, start it with `-D` so it will stay in the foreground and print debug messages. It should print something like this every couple of seconds:

```
polling ups: myups@localhost [SSL]
```

Obviously, if the `[SSL]` isn't there, something's broken.

10.5.5 Recommended: sniff the connection to see it for yourself

Using `tcpdump`, `Wireshark` (Ethereal), or another network sniffer tool, tell it to monitor port `3493/tcp` and see what happens. You should only see `STARTTLS` go out, `OK STARTTLS` come back, and the rest will be certificate data and then seemingly random characters.

If you see any plaintext besides that (`USERNAME`, `PASSWORD`, etc.) then something is not working.

10.5.6 Potential problems

If you specify a certificate expiration date, you will eventually see things like this in your syslog:

```
Oct 29 07:27:25 rktoy upsmon[3789]: Poll UPS [for750@rktoy] failed -
SSL error: error:14090086:SSL routines:SSL3_GET_SERVER_CERTIFICATE: certificate ←
verify failed
```

You can verify that it is expired by using `openssl` to display the date:

```
openssl x509 -enddate -noout -in <certfile>
```

It'll display a date like this:

```
notAfter=Oct 28 20:05:32 2002 GMT
```

If that's after the current date, you need to generate another cert/key pair using the procedure above.

10.5.7 Conclusion

SSL support should be considered stable but purposely under-documented since various bits of the implementation or configuration may change in the future. In other words, if you use this and it stops working after an upgrade, come back to this file to find out what changed.

This is why the other documentation doesn't mention any of these directives yet. SSL support is a treat for those of you that RTFM.

There are also potential licensing issues for people who ship binary packages since NUT is GPL and OpenSSL is not compatible with it. You can still build and use it yourself, but you can't distribute the results of it. Or maybe you can. It depends on what you consider "essential system software", and some other legal junk that we're not going to touch.

Other packages have solved this by explicitly stating that an exception has been granted. That is (purposely) impossible here, since NUT is the combined effort of many people, and all of them would have to agree to a license change. This is actually a feature, since it means nobody can unilaterally run off with the source — not even the NUT team.

Note that the replacement of OpenSSL by Mozilla Network Security Services (NSS) should avoid the above licensing issues.

10.6 chrooting and other forms of paranoia

It has been possible to run the drivers and `upsd` in a chrooted jail for some time, but it involved a number of evil hacks. From the 1.3 series, a much saner chroot behavior exists, using BIND 9 as an inspiration.

The old way involved creating an entire tree, complete with libraries, a shell (!), and many auxiliary files. This was hard to maintain and could have become an interesting playground for an intruder. The new way is minimal, and leaves little in the way of usable materials within the jail.

This document assumes that you already have created at least one user account for the software to use. If you're still letting it fall back on "nobody", stop right here and go figure that out first. It also assumes that you have everything else configured and running happily all by itself.

10.6.1 Generalities

Essentially, you need to create your configuration directory and state path in their own little world, plus a special device or two.

For the purposes of this example, the chroot jail is `/chroot/nut`. The programs have been built with the default prefix, so they are using `/usr/local/ups`. First, create the `confpath` and bring over a few files.

```
mkdir -p /chroot/nut/usr/local/ups/etc
cd /chroot/nut/usr/local/ups/etc
cp -a /usr/local/ups/etc/upsd.users .
cp -a /usr/local/ups/etc/upsd.conf .
cp -a /usr/local/ups/etc/ups.conf .
```

We're using `cp -a` to maintain the permissions on those files.

Now bring over your state path, maintaining the same permissions as before.

```
mkdir -p /chroot/nut/var/state
cp -a /var/state/ups /chroot/nut/var/state
```

Next we must put `/etc/localtime` inside the jail, or you may get very strange readings in your syslog. You'll know you have this problem if `upsd` shows up as UTC in the syslog while the rest of the system doesn't.

```
mkdir -p /chroot/nut/etc
cp /etc/localtime /chroot/nut/etc
```

Note that this is not `cp -a`, since we want to copy the **content**, not the symlink that it may be on some systems.

Finally, create a tiny bit of `/dev` so the programs can enter the background properly — they redirect file descriptors into the bit bucket to make sure nothing else grabs fds 0-2.

```
mkdir -p /chroot/nut/dev
cp -a /dev/null /chroot/nut/dev
```

Try to start your driver(s) and make sure everything fires up as before.

```
upsdrcvtl -r /chroot/nut -u nutdev start
```

Once your drivers are running properly, try starting `upsd`.

```
upsd -r /chroot/nut -u nutsrv
```

Check your syslog. If nothing is complaining, try running clients like `upsc` and `upsmon`. If they seem happy, then you're done.

10.6.2 symlinks

After you do this, you will have two copies of many things, like the `confpath` and the `state path`. I recommend deleting the *real* `/var/state/ups`, replacing it with a symlink to `/chroot/nut/var/state/ups`. That will let other programs reference the `.pid` files without a lot of hassle.

You can also do this with your `confpath` and point `/usr/local/ups/etc` (or equivalent on your system) at `/chroot/nut/usr/local/ups/etc` unless you're worried about something hurting the files inside that directory. In that case, you should maintain a *golden copy* and push it into the chroot path after making changes.

The `upsdrcvtl` itself does not chroot, so the `ups.conf` still needs to be in the usual `confpath`.

10.6.3 upsmon

This has not yet been applied to `upsmon`, since it can be quite complicated when there are notifiers that need to be run. One possibility would be for `upsmon` to have three instances:

- privileged root parent that listens for a shutdown command
- unprivileged child that listens for notify events
- unprivileged chrooted child that does network I/O

This one is messy, and may not happen for some time, if ever.

10.6.4 Config files

You may now set `chroot=` and `user=` in the global section of `ups.conf`.

The `upsd` chroots before opening any config files, so there is no way to add support for that in `upsd.conf` at the present time.

A Glossary

This section document the various acronyms used throughout the present documentation.

ATS

Automatic Transfer Switch.

NUT

Network UPS Tools.

PDU

Power Distribution Unit.

PSU

Power Supply Units.

SCD

Solar Controller Device.

UPS

Uninterruptible Power Supply.

B Acknowledgements / Contributions

Two NUT websites

This version of the page reflects NUT release *v2.8.0* with codebase committed ff16dabca at 2022-04-04T11:04:28+00:00
Options, features and capabilities in current development (and future releases) are detailed on the main site and may differ from ones described here.

This project is the result of years of work by many individuals and companies.

Many people have written or tweaked the software; the drivers, clients, server and documentation have all received valuable attention from numerous sources.

Many of them are listed within the source code, AUTHORS file, release notes, and mailing list archives, but some prefer to be anonymous. This software would not be possible without their help.

B.1 The NUT Team

B.1.1 Active members

- Jim Klimov: project leader (since 2020), OpenIndiana and OmniOS packager, CI ops and infra
 - Arnaud Quette: ex-project leader (from 2005 to 2020), Debian packager and jack of all trades
 - Charles Lepple: senior lieutenant
 - Daniele Pezzini: senior developer
 - Kjell Claesson: senior developer
 - Alexander Gordeev: junior developer
 - Michal Soltys: junior developer
 - David Goncalves: Python developer
 - Jean Perriault: web consultant
-

- Eric S. Raymond: Documentation consultant
- Roger Price: Documentation specialist
- Oden Eriksson: Mandriva packager
- Stanislav Brabec: Novell / SUSE packager
- Michal Hlavinka: Redhat packager
- Antoine Colombier: trainee

For an up to date list of NUT developers, refer to [GitHub](#).

B.1.2 Retired members

- Russell Kroll: Founder, and project leader from 1996 to 2005
- Arjen de Korte: senior lieutenant
- Peter Selinger: senior lieutenant
- Carlos Rodrigues: author of the "megatec" drivers, removing the numerous drivers for Megatec / Q1 protocol. These drivers have now been replaced by blazer_ser and blazer_usb
- Niels Baggesen: ported and heavily extended upscore2 to NUT 2.0 driver model
- Niklas Edmundsson: has worked on 3-phase support, and upscore2 updates
- Martin Loyer: has worked a bit on mge-utalk
- Jonathan Dion: MGE internship (summer 2006), who has worked on configuration
- Doug Reynolds: has worked on CyberPower support (powerpanel driver)
- Jon Gough: has worked on porting the megatec driver to USB (megatec_usb)
- Dominique Lallement: Consultant (chairman of the USB/HID PDC Forum)
- Julius Malkiewicz: junior developer
- Tomas Smetana: former Redhat packager (2007-2008)
- Frederic Bohe: senior developer, Eaton contractor (2009-2013)
- Emilien Kia: senior developer
- Václav Krpec: junior developer

B.2 Supporting manufacturers

B.2.1 UPS manufacturers

- [Eaton](#), has been the main NUT supporter in the past, between 2007 and 2011, continuing MGE UPS SYSTEMS efforts. As such, Eaton has been:
 - providing extensive technical documents (Eaton protocols library),
 - providing units to developers of NUT and related projects,
 - hosting the networkupstools.org webserver (from 2007 to August 2012),
 - providing artwork,
 - promoting NUT in general,
-

- supporting its customers using NUT.

**Warning**

The situation has evolved, and since 2011 Eaton does not support NUT anymore. This may still evolve in the future.

But for now, please do not consider anymore that buying Eaton products will provide you with official support from Eaton, or a better level of device support in NUT.

- **AMETEK Powervar**, through Andrew McCartney, has added support for all AMETEK Powervar UPM models as usb-hid UPS.
- **Gamatronic**, through Nadav Moskovitch, has revived the *sec* driver (as gamatronic), and expanded a bit genericups for its UPSs with alarm interface.
- **EVER Power Systems** added a USB HID subdriver for EVER UPSes (Sinline RT Series, Sinline RT XL Series, ECO PRO AVR CDS Series).
- **Microdowell**, through Elio Corbolante, has created the *microdowell* driver to support the Enterprise Nxx/Bxx serial devices. The company also proposes NUT as an alternative to its software for **Linux / Unix**.
- **Powercom**, through Alexey Morozov, has provided **extensive information** on its USB/HID devices, along with development units.
- **Riello UPS**, through Massimo Zampieri, has provided **all protocols information**. Elio Parisi has also created *riello_ser* and *riello_usb* to support these protocols.
- **Tripp Lite**, through Eric Cobb, has provided test results from connecting their HID-compliant UPS hardware to NUT. Some of this information has been incorporated into the NUT hardware compatibility list, and the rest of the information is available via the **list archives**.
- **NAG**, through Alexey Kazancev and Igor Ryabov, has added support for SNR-UPS-LID-XXXX models as usb-hid UPS.
- **Ablere Electronics Co., Ltd.** contributed the *ablerex* subdriver for *blazer_usb*, handling Ablerex MP, ARES Plus, MSII MSIII, GRs and GRs Plus models.

B.2.2 Appliances manufacturers

- **OpenGear** has worked with NUT's leader to successfully develop and integrate PDU support. Opendgear, through Scott Burns, and Robert Waldie, has submitted several patches.

B.3 Other contributors

- Pavel Korensky's original *apcd* provided the inspiration for pursuing APC's smart protocol in 1996
 - Eric Lawson provided scans of the OneAC protocol
 - John Marley used OCR software to transform the SEC protocol scans into a HTML document
 - Chris McKinnon scanned and converted the Fortress protocol documentation
 - Tank provided documentation on the Belkin/Delta protocol
 - Potrans provided a Fenton PowerPal 600 (P series) for development of the safenet driver.
-

B.4 Older entries (before 2005)

- MGE UPS SYSTEMS was the previous NUT sponsor, from 2002 until its partial acquisition by Eaton. They provided protocols information, many units for development of NUT-related projects. Several drivers such as mge-utalk, mge-shut, snmp-ups, hidups, and usbhid-ups are the result of this collaboration, in addition to the WMNut, MGE HID Parser the libhid projects, ... through Arnaud Quette (who was also an MGE employee). All the MGE supporters have gone with Eaton (through MGE Office Protection Systems), which was temporarily the new NUT sponsor.
- Fenton Technologies contributed a PowerPal 660 to the project. Their open stance and quick responses to technical inquiries were appreciated for making the development of the fentonups driver possible. Fenton has since been acquired by **Metapo**.
- Bo Kersey of **VirCIO** provided a Best Power Fortress 750 to facilitate the bestups driver.
- Invensys Energy Systems provided the SOLA/Best "Phoenixtec" protocol document. SOLA has since been acquired by Eaton.
- PowerKinetics technical support provided documentation on their MiniCOL protocol, which is archived in the NUT protocol library. PowerKinetics was acquired by the **JST Group** in June 2003.
- **Cyber Power Systems** contributed a 700AVR model for testing and development of the cyberpower driver.
- **Liebert Corporation** supplied serial test boxes and a UPStation GXT2 with the Web/SNMP card for development of the liebert driver and expansion of the existing snmp-ups driver. Liebert has since been acquired by **Emerson**.

Note

If a company or individual isn't listed here, then we probably don't have enough information about the situation. Developers are kindly requested to report vendor contributions to the NUT team so this list may reflect their help, as well as convey a sense of official support (at least, that drivers were proposed according to the know-how coming from specs and knowledge about hardware and firmware capabilities, and not acquired via reverse engineering with a certain degree of unreliability and incompleteness). If we have left you out, please send us some mail or post a pull request to update this document in GitHub.

C NUT command and variable naming scheme

Two NUT websites

This version of the page reflects NUT release *v2.8.0* with codebase committed ff16dabca at 2022-04-04T11:04:28+00:00. Options, features and capabilities in current development (and future releases) are detailed on the main site and may differ from ones described here.

RFC xxxx Recording Document

This document is defined by (pending) RFC xxxx and is referenced as the document of record for the variable names and the instant commands used in the protocol described by the RFC.

On behalf of the RFC, this document records the names of variables describing the abstracted state of an UPS or similar power distribution device, and the instant commands sent to the UPS using command `INSTCMD`, as used in commands and messages between the Attachment Daemon (the `upsd` in case of NUT implementation of the standard) and the clients.

This document defines the standard names of NUT commands and variables. Developers should use the names recorded here, with `dstate` functions and data mappings provided in NUT drivers for interactions with power devices.

If you need to express a state which cannot be described by any existing name, please make a request to the NUT developers' mailing list for definition and assignment of a new name. Clients using unrecorded names risk breaking at a future update. If you wish to experiment with new concepts before obtaining your requested variable name, you should use a name of the form `experimental.x.y` for those states.

Put another way: if you make up a name that is not in this list and it gets into the source code tree, and then the NUT community comes up with a better name later, clients that already use the undocumented variable will break when it is eventually changed. An explicitly "experimental" data point is less surprising in this regard.

Note

In the descriptions, "opaque" means programs should not attempt to parse the value for that variable as it may vary greatly from one UPS (or similar device) to the next. These strings are best handled directly by the user.

C.1 Time and Date format

When possible, dates should be expressed in ISO 8601 and RFC 3339 compatible Calendar format, that is to say "YYYY-MM-DD", or otherwise a Combined Date and Time representation (`<date>T<time>`, so "YYYY-MM-DDThh:mm"). Separators for the date (hyphen) and time (colon) components are required to conform to both ISO 8601 "extended" format and RFC 3339 required format.

In the case of Date and Time representation, a timezone can be added as per RFC 3339 and the newer revisions of the ISO 8601 standard (which allow for negative offsets):

- by appending the letter `Z` for UTC (e.g. "YYYY-MM-DDThh:mmZ"), or
- by appending the complete "hours:minutes" positive or negative time offsets from UTC (e.g. "YYYY-MM-DDThh:mm+03:00").

For more details see examples at [Wikipedia page on ISO 8601](#) and the publicly available RFC at [RFC 3339](#).

Other representations from those specifications are not necessarily supported.

C.2 Variables**C.2.1 device: General unit information****Note**

some of these data will be redundant with `ups.*` information during a transition period. The `ups.*` data will then be removed.

Name	Description	Example value
<code>device.model</code>	Device model	BladeUPS
<code>device.mfr</code>	Device manufacturer	Eaton
<code>device.serial</code>	Device serial number (opaque string)	WS9643050926
<code>device.type</code>	Device type (ups, pdu, scd, psu, ats)	ups
<code>device.description</code>	Device description (opaque string)	Some ups
<code>device.contact</code>	Device administrator name (opaque string)	John Doe
<code>device.location</code>	Device physical location (opaque string)	1st floor
<code>device.part</code>	Device part number (opaque string)	123456789
<code>device.macaddr</code>	Physical network address of the device	68:b5:99:f5:89:27
<code>device.uptime</code>	Device uptime in seconds	1782
<code>device.count</code>	Total number of daisy chained devices	1

Note

When present, `device.count` implies daisychain support. For more information, refer to the [NUT daisychain support notes](#) chapter of the user manual and developer guide.

C.2.2 ups: General unit information

Name	Description	Example value
ups.status	UPS status	OL
ups.alarm	UPS alarms	OVERHEAT
ups.time	Internal UPS clock time (opaque string)	12:34
ups.date	Internal UPS clock date (opaque string)	01-02-03
ups.model	UPS model	SMART-UPS 700
ups.mfr	UPS manufacturer	APC
ups.mfr.date	UPS manufacturing date (opaque string)	10/17/96
ups.serial	UPS serial number (opaque string)	WS9643050926
ups.vendorid	Vendor ID for USB devices	0463
ups.productid	Product ID for USB devices	0001
ups.firmware	UPS firmware (opaque string)	50.9.D
ups.firmware.aux	Auxiliary device firmware	4Kx
ups.temperature	UPS temperature (degrees C)	042.7
ups.load	Load on UPS (percent)	023.4
ups.load.high	Load when UPS switches to overload condition ("OVER") (percent)	100
ups.id	UPS system identifier (opaque string)	Sierra
ups.delay.start	Interval to wait before restarting the load (seconds)	0
ups.delay.reboot	Interval to wait before rebooting the UPS (seconds)	60
ups.delay.shutdown	Interval to wait after shutdown with delay command (seconds)	20
ups.timer.start	Time before the load will be started (seconds)	30
ups.timer.reboot	Time before the load will be rebooted (seconds)	10
ups.timer.shutdown	Time before the load will be shutdown (seconds)	20
ups.test.interval	Interval between self tests (seconds)	1209600 (two weeks)
ups.test.result	Results of last self test (opaque string)	Bad battery pack
ups.test.date	Date of last self test (opaque string)	07/17/12
ups.display.language	Language to use on front panel (* opaque)	E
ups.contacts	UPS external contact sensors (* opaque)	F0
ups.efficiency	Efficiency of the UPS (ratio of the output current on the input current) (percent)	95
ups.power	Current value of apparent power (Volt-Amps)	500
ups.power.nominal	Nominal value of apparent power (Volt-Amps)	500
ups.realpower	Current value of real power (Watts)	300
ups.realpower.nominal	Nominal value of real power (Watts)	300
ups.beeper.status	UPS beeper status (enabled, disabled or muted)	enabled
ups.type	UPS type (* opaque)	offline
ups.watchdog.status	UPS watchdog status (enabled or disabled)	disabled
ups.start.auto	UPS starts when mains is (re)applied	yes
ups.start.battery	Allow to start UPS from battery	yes

Name	Description	Example value
ups.start.reboot	UPS coldstarts from battery (enabled or disabled)	yes
ups.shutdown	Enable or disable UPS shutdown ability (poweroff)	enabled

Note

When present, the value of `ups.start.auto` has an impact on `shutdown.*` commands. For the sake of coherence, shutdown commands will set `ups.start.auto` to the right value before issuing the command. That is, `shutdown.stayoff` will first set `ups.start.auto` to `no`, while `shutdown.return` will set it to `yes`.

Note

When possible, time-stamps and dates should be expressed as detailed above in the Time and Date format chapter.

C.2.3 input: Incoming line/power information

Name	Description	Example value
input.voltage	Input voltage (V)	121.5
input.voltage.maximum	Maximum incoming voltage seen (V)	130
input.voltage.minimum	Minimum incoming voltage seen (V)	100
input.voltage.status	Status relative to the thresholds	critical-low
input.voltage.low.warning	Low warning threshold (V)	205
input.voltage.low.critical	Low critical threshold (V)	200
input.voltage.high.warning	High warning threshold (V)	230
input.voltage.high.critical	High critical threshold (V)	240
input.voltage.nominal	Nominal input voltage (V)	120
input.voltage.extended	Extended input voltage range	no
input.transfer.delay	Delay before transfer to mains (seconds)	60
input.transfer.reason	Reason for last transfer to battery (* opaque)	T
input.transfer.low	Low voltage transfer point (V)	91
input.transfer.high	High voltage transfer point (V)	132
input.transfer.low.min	smallest settable low voltage transfer point (V)	85
input.transfer.low.max	greatest settable low voltage transfer point (V)	95
input.transfer.high.min	smallest settable high voltage transfer point (V)	131
input.transfer.high.max	greatest settable high voltage transfer point (V)	136
input.sensitivity	Input power sensitivity	H (high)
input.quality	Input power quality (* opaque)	FF
input.current	Input current (A)	4.25
input.current.nominal	Nominal input current (A)	5.0
input.current.status	Status relative to the thresholds	critical-high
input.current.low.warning	Low warning threshold (A)	4
input.current.low.critical	Low critical threshold (A)	2
input.current.high.warning	High warning threshold (A)	10
input.current.high.critical	High critical threshold (A)	12
input.frequency	Input line frequency (Hz)	60.00
input.frequency.nominal	Nominal input line frequency (Hz)	60

Name	Description	Example value
input.frequency.status	Frequency status	out-of-range
input.frequency.low	Input line frequency low (Hz)	47
input.frequency.high	Input line frequency high (Hz)	63
input.frequency.extended	Extended input frequency range	no
input.transfer.boost.low	Low voltage boosting transfer point (V)	190
input.transfer.boost.high	High voltage boosting transfer point (V)	210
input.transfer.trim.low	Low voltage trimming transfer point (V)	230
input.transfer.trim.high	High voltage trimming transfer point (V)	240
input.load	Load on (ePDU) input (percent of full)	25
input.realpower	Current sum value of all (ePDU) phases real power (W)	300
input.realpower.nominal	Nominal sum value of all (ePDU) phases real power (W)	850
input.power	Current sum value of all (ePDU) phases apparent power (VA)	500
input.source	The current input power source	1
input.source.preferred	The preferred power source	1
input.phase.shift	Voltage dephasing between input sources (degrees)	181

C.2.4 output: Outgoing power/inverter information

Name	Description	Example value
output.voltage	Output voltage (V)	120.9
output.voltage.nominal	Nominal output voltage (V)	120
output.frequency	Output frequency (Hz)	59.9
output.frequency.nominal	Nominal output frequency (Hz)	60
output.current	Output current (A)	4.25
output.current.nominal	Nominal output current (A)	5.0

C.2.5 Three-phase additions

The additions for three-phase measurements would produce a very long table due to all the combinations that are possible, so these additions are broken down to their base components.

Phase Count Determination

`input.phases` (3 for three-phase, absent or 1 for 1phase)

`output.phases` (as for `input.phases`)

DOMAINS

Any input or output is considered a valid DOMAIN.

- input (should really be called `input.mains`, but keep this for compat)
 - `input.bypass`
 - `input.servicebypass`

- output (should really be called output.load, but keep this for compat)
 - output.bypass
 - output.inverter
 - output.servicebypass

Specification (SPEC)

Voltage, current, frequency, etc are considered to be a specification of the measurement.

With this notation, the old 1phase naming scheme becomes DOMAIN.SPEC

Example: `input.current`

CONTEXT

When in three-phase mode, we need some way to specify the target for most measurements in more detail. We call this the CONTEXT.

With this notation, the naming scheme becomes DOMAIN.CONTEXT.SPEC when in three-phase mode.

Example: `input.L1.current`

Valid CONTEXTS

```
L1-L2 \
L2-L3 \
L3-L1   for voltage measurements
L1-N   /
L2-N   /
L3-N   /
```

```
L1 \
L2  for current and power measurements
L3 /
N  - for current measurement
```

Valid SPECS

Valid with/without context (i.e. per phase or aggregated/averaged)

Name	Description
alarm	Alarms for phases, published in ups.alarm
current	Current (A)
current.maximum	Maximum seen current (A)
current.minimum	Minimum seen current (A)
current.status	Status relative to the thresholds
current.low.warning	Low warning threshold (A)
current.low.critical	Low critical threshold (A)
current.high.warning	High warning threshold (A)
current.high.critical	High critical threshold (A)
current.peak	Peak current
voltage	Voltage (V)
voltage.nominal	Nominal voltage (V)
voltage.maximum	Maximum seen voltage (V)
voltage.minimum	Minimum seen voltage (V)

Name	Description
voltage.status	Status relative to the thresholds
voltage.low.warning	Low warning threshold (V)
voltage.low.critical	Low critical threshold (V)
voltage.high.warning	High warning threshold (V)
voltage.high.critical	High critical threshold (V)
power	Apparent power (VA)
power.maximum	Maximum seen apparent power (VA)
power.minimum	Minimum seen apparent power (VA)
power.percent	Percentage of apparent power related to maximum load
power.maximum.percent	Maximum seen percentage of apparent power
power.minimum.percent	Minimum seen percentage of apparent power
realpower	Real power (W)
powerfactor	Power Factor (dimensionless value between 0.00 and 1.00)
crestfactor	Crest Factor (dimensionless value greater or equal to 1)
load	Load on (ePDU) input

Valid without context (i.e. aggregation of all phases):

Name	Description
frequency	Frequency (Hz)
frequency.nominal	Nominal frequency (Hz)
realpower	Current value of real power (Watts)
power	Current value of apparent power (Volt-Amps)

C.2.6 EXAMPLES

Partial Three phase — Three phase example:

```
input.phases: 3
input.frequency: 50.0
input.L1.current: 133.0
input.bypass.L1-L2.voltage: 398.3
output.phases: 3
output.L1.power: 35700
output.powerfactor: 0.82
```

Partial Three phase — One phase example:

```
input.phases: 3
input.L2.current: 48.2
input.N.current: 3.4
input.L3-L1.voltage: 405.4
input.frequency: 50.1
output.phases: 1
output.current: 244.2
output.voltage: 120
output.frequency.nominal: 60.0
```

C.2.7 battery: Any battery details

Name	Description	Example value
battery.charge	Battery charge (percent)	100.0

Name	Description	Example value
battery.charge.approx	Rough approximation of battery charge (opaque, percent)	<85
battery.charge.low	Remaining battery level when UPS switches to LB (percent)	20
battery.charge.restart	Minimum battery level for UPS restart after power-off	20
battery.charge.warning	Battery level when UPS switches to "Warning" state (percent)	50
battery.charger.status	Status of the battery charger (see the note below)	charging
battery.voltage	Battery voltage (V)	24.84
battery.voltage.cell.max	Maximum battery voltage seen of the Li-ion cell (V)	3.44
battery.voltage.cell.min	Minimum battery voltage seen of the Li-ion cell (V)	3.41
battery.voltage.nominal	Nominal battery voltage (V)	024
battery.voltage.low	Minimum battery voltage, that triggers FSD status	21,52
battery.voltage.high	Maximum battery voltage (i.e. battery.charge = 100)	26,9
battery.capacity	Battery capacity (Ah)	7.2
battery.capacity.nominal	Nominal battery capacity (Ah)	8.0
battery.current	Battery current (A)	1.19
battery.current.total	Total battery current (A)	1.19
battery.status	Health status of the battery (opaque string)	ok
battery.temperature	Battery temperature (degrees C)	050.7
battery.temperature.cell.max	Maximum battery temperature seen of the Li-ion cell (degrees C)	25.85
battery.temperature.cell.min	Minimum battery temperature seen of the Li-ion cell (degrees C)	24.85
battery.runtime	Battery runtime (seconds)	1080
battery.runtime.low	Remaining battery runtime when UPS switches to LB (seconds)	180
battery.runtime.restart	Minimum battery runtime for UPS restart after power-off (seconds)	120
battery.alarm.threshold	Battery alarm threshold	0 (immediate)
battery.date	Battery installation or last change date (opaque string)	11/14/20
battery.date.maintenance	Battery next change or maintenance date (opaque string)	11/13/24
battery.mfr.date	Battery manufacturing date (opaque string)	2005/04/02
battery.packs	Number of internal battery packs	1
battery.packs.bad	Number of bad battery packs	0
battery.packs.external	Number of external battery packs	1
battery.type	Battery chemistry (opaque string)	PbAc
battery.protection	Prevent deep discharge of battery	yes
battery.energysave	Switch off when running on battery and no/low load	no
battery.energysave.load	Switch off UPS if on battery and load level lower (percent)	5
battery.energysave.delay	Delay before switch off UPS if on battery and load level low (min)	3

Name	Description	Example value
battery.energysave.realpower	Switch off UPS if on battery and load level lower (Watts)	10

NOTE: `battery.charger.status` replaces the historic flags `CHRG` and `DISCHRG` that were exposed through `ups.status`. The `battery.charger.status` can have one of the following values:

- `charging`: battery is charging,
- `discharging`: battery is discharging,
- `floating`: battery has completed its charge cycle, and waiting to go to resting mode,
- `resting`: the battery is fully charged, and not charging nor discharging.

Note

When possible, time-stamps and dates should be expressed as detailed above in the Time and Date format chapter.

C.2.8 ambient: Conditions from external probe equipment

Note

multiple sensors can be exposed using the indexed notation. `ambient.*`, without index or using `0`, relates to the embedded sensor. For example: `ambient.temperature` represent the embedded sensor temperature. Other sensors (external, communication card, ...) can use indexes from `1` to `n`. For example: `ambient.1.temperature` for the first external sensor temperature.

Name	Description	Example value
ambient.n.present	Ambient sensor presence	yes
ambient.n.temperature	Ambient temperature (degrees C)	25.40
ambient.n.temperature.alarm	Temperature alarm (enabled/disabled)	enabled
ambient.n.temperature.status	Ambient temperature status relative to the thresholds	warning-low
ambient.n.temperature.high	Temperature threshold high (degrees C)	60
ambient.n.temperature.high.warning	Temperature threshold high warning (degrees C)	40
ambient.n.temperature.high.critical	Temperature threshold high critical (degrees C)	60
ambient.n.temperature.low	Temperature threshold low (degrees C)	5
ambient.n.temperature.low.warning	Temperature threshold low warning (degrees C)	10
ambient.n.temperature.low.critical	Temperature threshold low critical (degrees C)	5
ambient.n.temperature.maximum	Maximum temperature seen (degrees C)	37.6
ambient.n.temperature.minimum	Minimum temperature seen (degrees C)	18.1
ambient.n.humidity	Ambient relative humidity (percent)	038.8
ambient.n.humidity.alarm	Relative humidity alarm (enabled/disabled)	enabled
ambient.n.humidity.status	Ambient humidity status relative to the thresholds	warning-low

Name	Description	Example value
ambient.n.humidity.high	Relative humidity threshold high (percent)	80
ambient.n.humidity.high.warning	Relative humidity threshold high warning (percent)	70
ambient.n.humidity.high.critical	Relative humidity threshold high critical (percent)	80
ambient.n.humidity.low	Relative humidity threshold low (percent)	10
ambient.n.humidity.low.warning	Relative humidity threshold low warning (percent)	20
ambient.n.humidity.low.critical	Relative humidity threshold low critical (percent)	10
ambient.n.humidity.maximum	Maximum relative humidity seen (percent)	60
ambient.n.humidity.minimum	Minimum relative humidity seen (percent)	13
ambient.n.contacts.x.status	State of the dry contact sensor x	open

C.2.9 outlet: Smart outlet management

Note

n stands for the outlet index. A special case is "outlet.0" which is equivalent to "outlet" (without index), and represent the whole set of outlets of the device. The most important data is "outlet.count", used to iterate over the whole set of outlets. For more information, refer to the NUT outlets management and PDU notes chapter of the user manual.

Name	Description	Example value
outlet.count	Total number of outlets	12
outlet.switchable	General outlet switch ability of the unit (yes/no)	yes
outlet.n.id	Outlet system identifier (opaque string)	1
outlet.n.name	Outlet name (opaque string)	A1
outlet.n.desc	Outlet description (opaque string)	Main outlet
outlet.n.groupid	Identifier of the group to which the outlet belongs to	1
outlet.n.switch	Outlet switch control (on/off)	on
outlet.n.status	Outlet switch status (on/off)	on
outlet.n.alarm	Alarms for outlets and PDU, published in ups.alarm	outlet 1 low voltage warning
outlet.n.switchable	Outlet switch ability (yes/no)	yes
outlet.n.autoswitch.charge.low	Remaining battery level to power off this outlet (percent)	80
outlet.n.battery.charge.low	Remaining battery level to power off this outlet (percent)	80
outlet.n.delay.shutdown	Interval to wait before shutting down this outlet (seconds)	180
outlet.n.delay.start	Interval to wait before restarting this outlet (seconds)	120
outlet.n.timer.shutdown	Time before the outlet load will be shutdown (seconds)	20
outlet.n.timer.start	Time before the outlet load will be started (seconds)	30
outlet.n.current	Current (A)	0.19

Name	Description	Example value
outlet.n.current.maximum	Maximum seen current (A)	0.56
outlet.n.current.status	Current status relative to the thresholds	good
outlet.n.current.low.warning	Low warning threshold (A)	0.10
outlet.n.current.low.critical	Low critical threshold (A)	0.05
outlet.n.current.high.warning	High warning threshold (A)	0.30
outlet.n.current.high.critical	High critical threshold (A)	0.40
outlet.n.realpower	Current value of real power (W)	28
outlet.n.voltage	Voltage (V)	247.0
outlet.n.voltage.status	Voltage status relative to the thresholds	good
outlet.n.voltage.low.warning	Low warning threshold (V)	205
outlet.n.voltage.low.critical	Low critical threshold (V)	200
outlet.n.voltage.high.warning	High warning threshold (V)	230
outlet.n.voltage.high.critical	High critical threshold (V)	240
outlet.n.powerfactor	Power Factor (dimensionless, value between 0 and 1)	0.85
outlet.n.crestfactor	Crest Factor (dimensionless, equal to or greater than 1)	1.41
outlet.n.power	Apparent power (VA)	46
outlet.n.type	Physical outlet type	french

outlet.group: groups of smart outlets

This is a refinement of the outlet collection, providing grouped management for a set of outlets. The same principles and data than the outlet collection apply to outlet.group, especially for the indexing *n* and "outlet.group.count".

Most of the data published for outlets also apply to outlet.group, including: id, name (similar as outlet "desc"), status, current and voltage (including status, alarm and thresholds).

Some specific data to outlet groups exists:

Name	Description	Example value
outlet.group.n.type	Type of outlet group (OPAQUE)	outlet-section
outlet.group.n.color	Color-coding of the outlets in this group (OPAQUE)	yellow
outlet.group.n.count	Number of outlets in the group	12
outlet.group.n.phase	Electrical phase to which the physical outlet group (Gang) is connected to	L1

Example:

```

outlet.group.1.current: 0.00
outlet.group.1.current.high.critical: 16.00
outlet.group.1.current.high.warning: 12.80
outlet.group.1.current.low.warning: 0.00
outlet.group.1.current.nominal: 16.00
outlet.group.1.current.status: good
outlet.group.1.id: 1
outlet.group.1.name: Branch Circuit A
outlet.group.1.phase: L1
outlet.group.1.status: on
outlet.group.1.voltage: 244.23
outlet.group.1.voltage.high.critical: 265.00
outlet.group.1.voltage.high.warning: 255.00
outlet.group.1.voltage.low.critical: 180.00

```

```

outlet.group.1.voltage.low.warning: 190.00
outlet.group.1.voltage.status: good
...
outlet.group.count: 3.00

```

C.2.10 driver: Internal driver information

Name	Description	Example value
driver.name	Driver name	usbhid-ups
driver.version	Driver version (NUT release)	X.Y.Z
driver.version.internal	Internal driver version	1.23.45
driver.version.data	Version of the internal data mapping, for generic drivers	Eaton HID 1.31
driver.version.usb	USB library version	libusb-1.0.21
driver.parameter.xxx	Parameter xxx (ups.conf or cmdline -x) setting	(varies)
driver.flag.xxx	Flag xxx (ups.conf or cmdline -x) status	enabled (or absent)

C.2.11 server: Internal server information

Name	Description	Example value
server.info	Server information	Network UPS Tools upsd vX.Y.Z - http://www.networkupstools.org/
server.version	Server version	X.Y.Z

C.3 Instant commands

Name	Description
load.off	Turn off the load immediately
load.on	Turn on the load immediately
load.off.delay	Turn off the load possibly after a delay
load.on.delay	Turn on the load possibly after a delay
shutdown.return	Turn off the load possibly after a delay and return when power is back
shutdown.stayoff	Turn off the load possibly after a delay and remain off even if power returns
shutdown.stop	Stop a shutdown in progress
shutdown.reboot	Shut down the load briefly while rebooting the UPS
shutdown.reboot.graceful	After a delay, shut down the load briefly while rebooting the UPS
test.panel.start	Start testing the UPS panel
test.panel.stop	Stop a UPS panel test
test.failure.start	Start a simulated power failure
test.failure.stop	Stop simulating a power failure
test.battery.start	Start a battery test
test.battery.start.quick	Start a "quick" battery test
test.battery.start.deep	Start a "deep" battery test
test.battery.stop	Stop the battery test
test.system.start	Start a system test
calibrate.start	Start runtime calibration
calibrate.stop	Stop runtime calibration

Name	Description
bypass.start	Put the UPS in bypass mode
bypass.stop	Take the UPS out of bypass mode
reset.input.minmax	Reset minimum and maximum input voltage status
reset.watchdog	Reset watchdog timer (forced reboot of load)
beeper.enable	Enable UPS beeper/buzzer
beeper.disable	Disable UPS beeper/buzzer
beeper.mute	Temporarily mute UPS beeper/buzzer
beeper.toggle	Toggle UPS beeper/buzzer
outlet.n.shutdown.return	Turn off the outlet possibly after a delay and return when power is back
outlet.n.load.off	Turn off the outlet immediately
outlet.n.load.on	Turn on the outlet immediately
outlet.n.load.cycle	Power cycle the outlet immediately
outlet.n.shutdown.return	Turn off the outlet and return when power is back

D Hardware Compatibility List

Refer to the [online HCL](#).

E Documentation

Two NUT websites

This version of the page reflects NUT release *v2.8.0* with codebase committed ff16dabca at 2022-04-04T11:04:28+00:00. Options, features and capabilities in current development (and future releases) are detailed on the main site and may differ from ones described here.

E.1 User Documentation

- [FAQ - Frequently Asked Questions](#)
- [NUT user manual](#)
- [Cables information](#)
- [User manual pages](#)
- [Devices Dumps Library \(DDL\)](#): Provides information on how devices are supported
- [Notes on NUT monitoring of USB devices in Solaris and related operating systems](#)

E.2 Developer Documentation

- [NUT Developer Guide](#)
- [NUT Packager Guide](#)
- [UPS protocols library](#)
- [Developer manual pages](#)
- [NUT Quality Assurance](#)
- [Devices Dumps Library \(DDL\)](#): Provides simulation data to the `dummy-ups(8)` driver

E.3 Data dumps for the DDL

Note: both developers contributing a driver and users using an existing driver for device not previously documented as supported by it, are welcome to report new data for the Devices Dumps Library (DDL) mentioned above. Best of all such "data dump" reports can be prepared by the `./tools/nut-ddl-dump.sh` script from the main NUT codebase, and reported on the NUT mailing list or via [NUT issues on GitHub](#) or as a pull request against the [NUT Devices Dumps Library](#) following the naming and other rules described in the DDL documentation page.

Data dumps collected by the tools above, or by `upsc` client, or by drivers in exploratory data-dumping mode (with `-d 1` argument), can be compared by `./tools/nut-dumpdiff.sh` script from the main NUT codebase, which strips away lines with only numeric values (aiming to minimize the risk of losing meaningful changes like counters).

E.4 Offsite Links

These are general information about UPS, PDU, ATS, PSU and SCD:

- [UPS HOWTO](#) (The Linux Documentation Project)
- [UPS on Wikipedia](#)
- [PDU on Wikipedia](#)
- [Automatic Transfer Switch](#)
- [Power Supply Units](#)
- [Solar controller on Wikipedia](#)
- [UPS on The PC Guide](#)

These are writeups by users of the software.

- [NUT Setup with openSUSE](#) (*Roger Price*)
- [Deploying NUT on an Ubuntu 10.04 cluster](#) (*Stefano Angelone*)
- [Monitoring a UPS with nut on Debian or Ubuntu Linux](#) (*Avery Fay*)
- [Installation et gestion d'un UPS USB en réseau sous linux](#) (*Olivier Van Hoof, french*)
- [Network UPS Tools \(NUT\) on Mac OS X \(10.4.10\)](#) (*Andy Poush*)
- [Interfacing a Contact-Closure UPS to Mac OS X and Linux](#) (*David Hough*)
- [How to use UPS with nut on RedHat / Fedora Core](#) (*Kazutoshi Morioka*)
- [FreeBSD installation procedure](#) (*Thierry Thomas, from FreeBSD*)
- [Gestionando un SAI desde OpenBSD con NUT](#) (*Juan J. Martinez, spanish*)
- [HOWTO: MGE Ellipse 300 on gentoo](#) (*nielchiano*)
- [Cum se configurează un UPS Apollo seria 1000F pe Linux](#) (*deschis, Romanian*)
- [Install a UPS \(nut\) on a Buffalo NAS](#) (*various authors*)
- [NUT Korean GuideBook](#) (*PointBre*)
- [USB UPS, notifications, and Home Assistant](#) (*James Ridgway*)

Video articles are also available:

- [Network UPS Tools \(NUT Server\) Ultimate Guide](#) (*Techno Tim*)

E.5 News articles and Press releases

- [Linux UPS Without Tears](#) (*A. Lizard*)
- [Graceful UPS shutdowns on Linux](#) (*Carla Schroder*)

F Support instructions

Two NUT websites

This version of the page reflects NUT release *v2.8.0* with codebase committed *ff16dabca* at *2022-04-04T11:04:28+00:00*. Options, features and capabilities in current development (and future releases) are detailed on the main site and may differ from ones described here.

There are various ways to obtain support for NUT.

F.1 Documentation

- First, be sure to read the [FAQ](#). The most common problems are already addressed there.
- Else, you can read the [NUT user manual](#). It also covers many areas about installing, configuring and using NUT. The specific steps on system integration are also discussed.
- Finally, [User manual pages](#) will also complete the User Manual provided information. At least, read the manual page related to your driver(s).

F.2 Mailing lists

If you have still not found a solution, you should search the lists before posting a question.

Someone may have already solved the problem:

[search on the NUT lists using Google](#)

Finally, you can **subscribe** to a NUT mailing list to:

F.2.1 Request help

Use the [NUT Users](#) mailing list.

In this case, be sure to include the following information:

- OS name and version,
- exact NUT version,
- NUT installation method: package, or a custom build from source tarball or GitHub (which fork, branch, PR),
- exact device name and related information (manufacturing date, web pointers, ...),
- complete problem description, with any relevant traces, like system log excerpts, and driver debug output. You can obtain the latter using the following command, running as root and after having stopped NUT:

```
/path/to/driver -DD -a <upsname>
```

If you don't include the above information in your help request, we will not be able to help you!

F.2.2 Post a patch, ask a development question, ...

Use the [NUT Developers](#) mailing list.

Refer to the [NUT Developer Guide](#) for more information, and the chapter on how to [submit patches](#).

Note that the currently preferable way for ultimate submission of improvements is to [post a pull request](#) from your GitHub fork of NUT. Benefits of PRs include automated testing and merge-conflict detection and resolution, as well as tracking discussion that is often needed to better understand, integrate or document the patch.

F.2.3 Discuss packaging and related topics

Use the [NUT Packagers](#) mailing list.

Refer to the [NUT Packager Guide](#) for more information.

F.3 IRC (Internet Relay Chat)

Yes, we're open!

There is an official `#nut` channel on <https://libera.chat/> network.

Feel free to hang out with whoever is on-line at the moment, or watch reports from the NUT CI farm as they come.

Please don't forget the basics of netiquette, such as that any help is done on a best-effort basis, people have other obligations, and are not always there even if their chat client is, and that respect and politeness are the norm (this includes doing some research before asking, and explaining the context where it is not trivial).

F.4 GitHub Issues

See <https://github.com/networkupstools/nut/issues> for another venue of asking (and answering) questions, as well as proposing improvements.

To report new Devices Dumps Library entries, posting an issue is okay, but posting a [pull request](#) is a lot better—easier for maintainers to review and merge any time. For some more detailed instructions about useful DDL reports, please see [NUT DDL page](#).

G Cables information

Two NUT websites

This version of the page reflects NUT release *v2.8.0* with codebase committed `ff16dabca` at `2022-04-04T11:04:28+00:00`

Options, features and capabilities in current development (and future releases) are detailed on the main site and may differ from ones described here.

G.1 APC

G.1.1 940-0024C clone

From D. Stimits

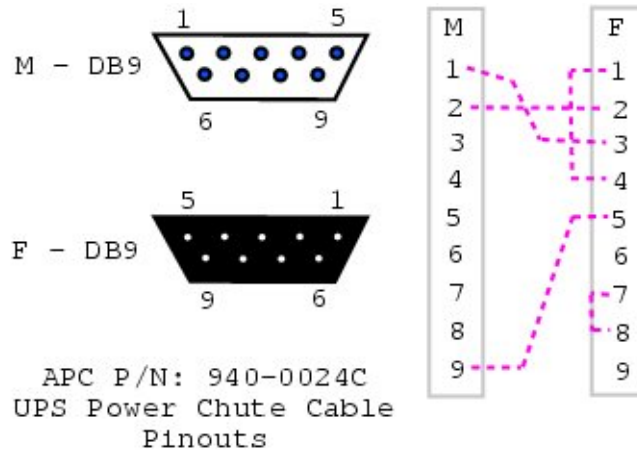

Note
The original 940-0024C diagram was contributed by Steve Draper.

G.1.2 940-0024E clone

Reported by Jonathan Laventhol

This cable is said to use the same wiring as 940-0024C clone.

G.1.3 940-0024C clone for Macs

From Miguel Howard

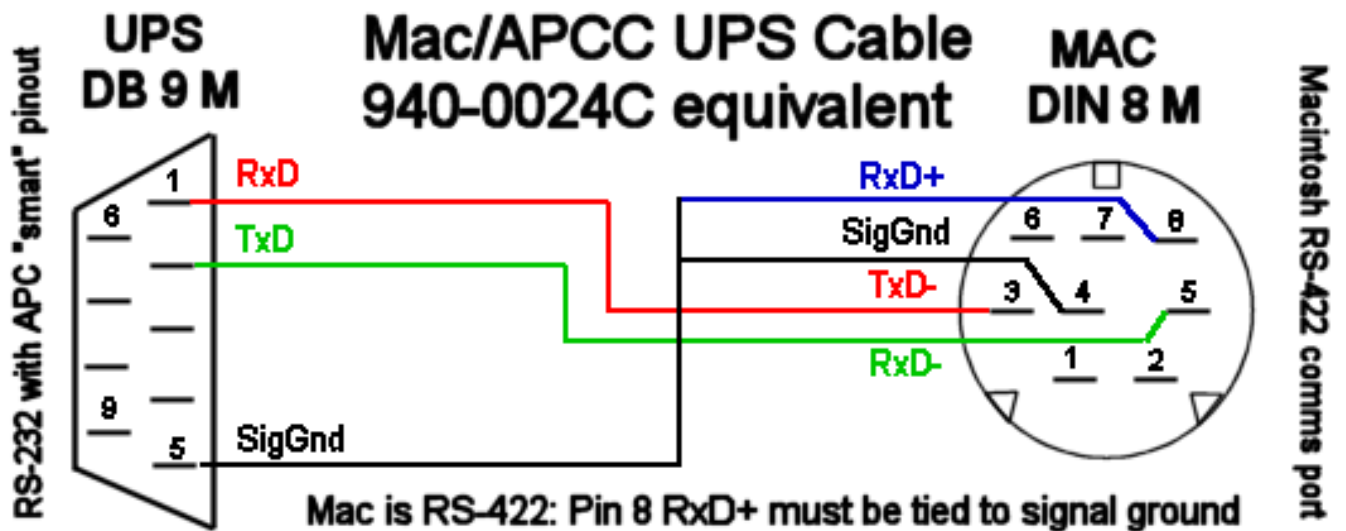

G.2 Belkin

G.2.1 OmniGuard F6C*-RKM**

From "Daniel"

A straight-through RS-232 cable (with pins 2-7 connected through) should work with the following models:

- F6C110-RKM-2U
- F6C150-RKM-2U
- F6C230-RKM-2U
- F6C320-RKM-3U

● RS232

Character based protocol

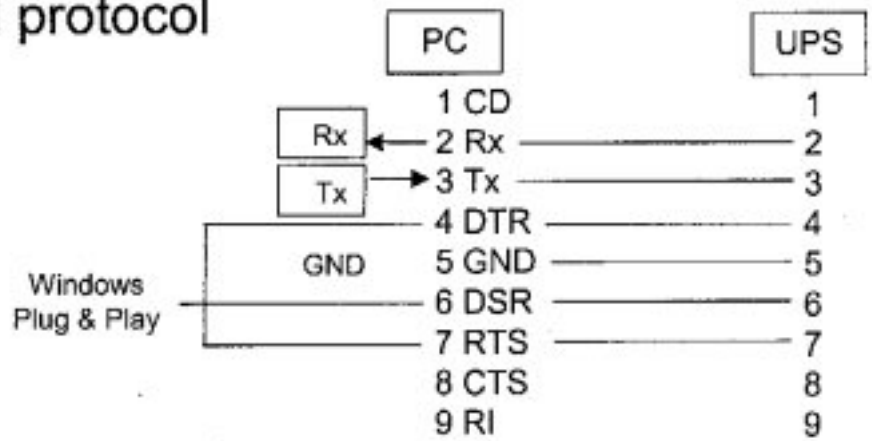

G.3 Eaton

Documents in this section are provided courtesy of Eaton.

G.3.1 MGE Office Protection Systems

The three first cables also applies to MGE UPS SYSTEMS and Eaton.

DB9-DB9 cable (ref 66049)

This is the standard serial cable, used on most units.

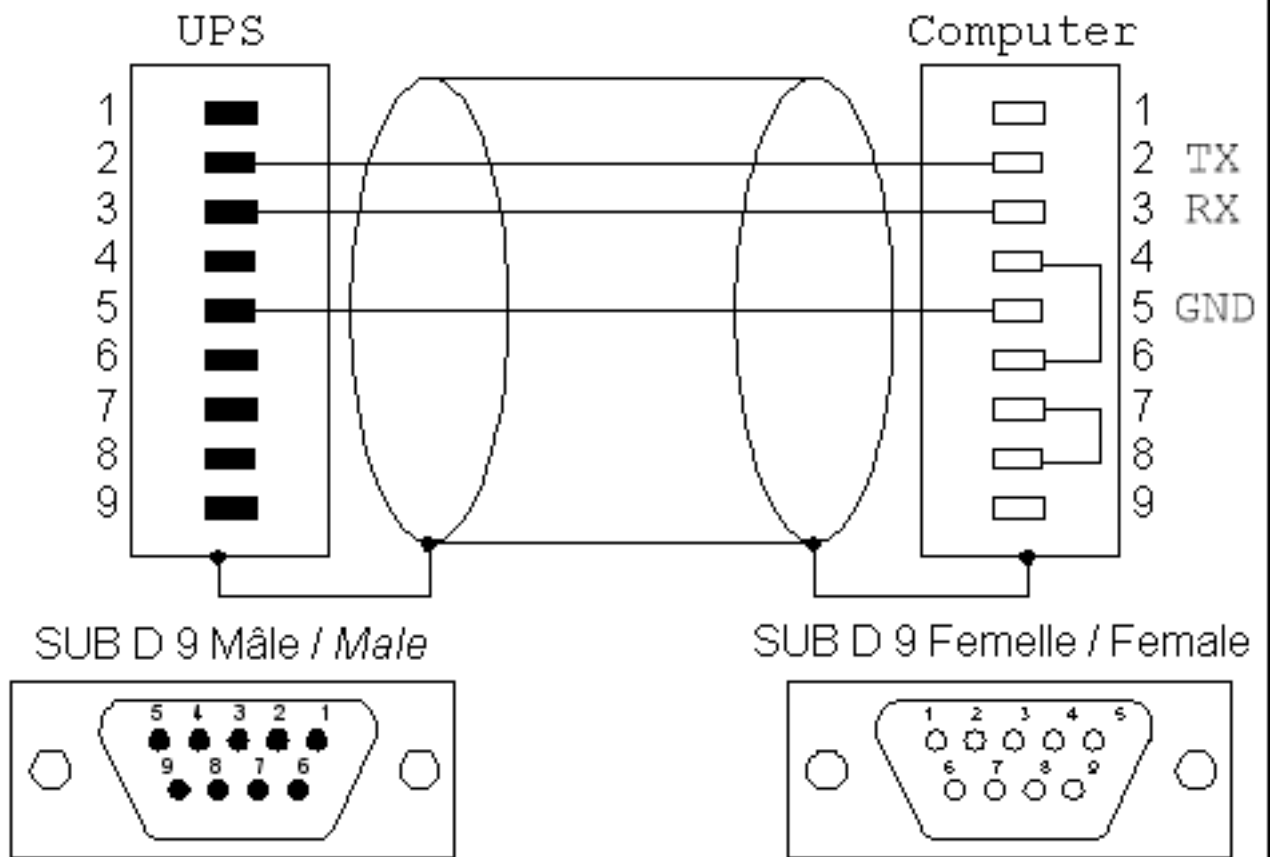

DB9-RJ45 cable

This cable is used on the more recent models, including Ellipse MAX, Protection Station, ...

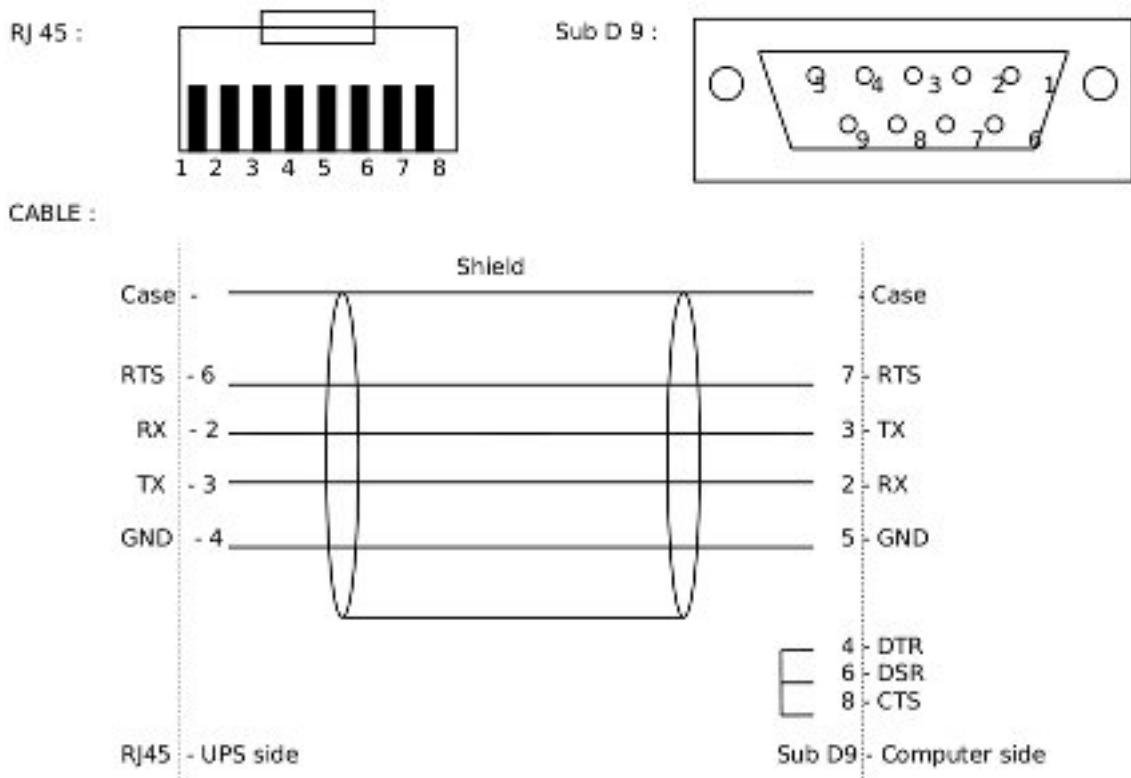

NMC DB9-RJ45 cable

The following applies to the MGE 66102 NMC (Network Management Card), and possibly other models. The NMC connection is an 8P8C RJ45-style jack.

Signal	PC	NMC
	1,4,6	
TxD	2	3
RxD	3	6
GND	5	4
	7,8	
	shield	shield

USB-RJ45 cable

This cable is used also on the more recent models, including Ellipse MAX, Protection Station, ...

CABLE :

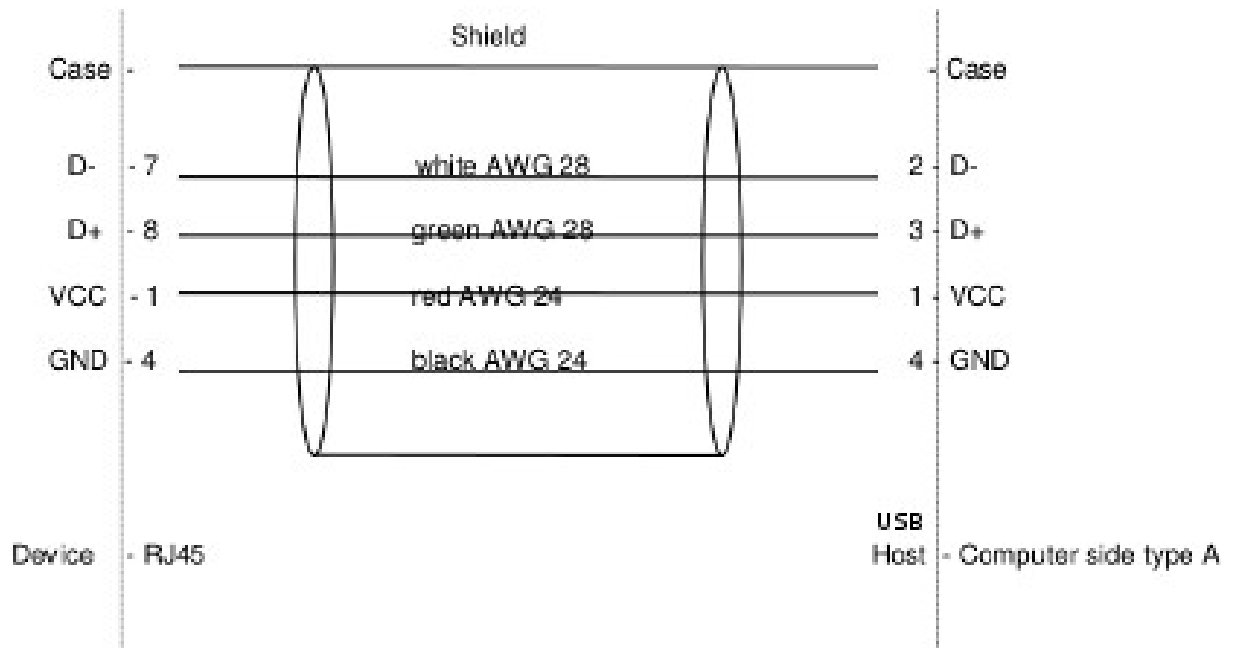

DB9-RJ12 cable

This cable is used on some older Ellipse models.

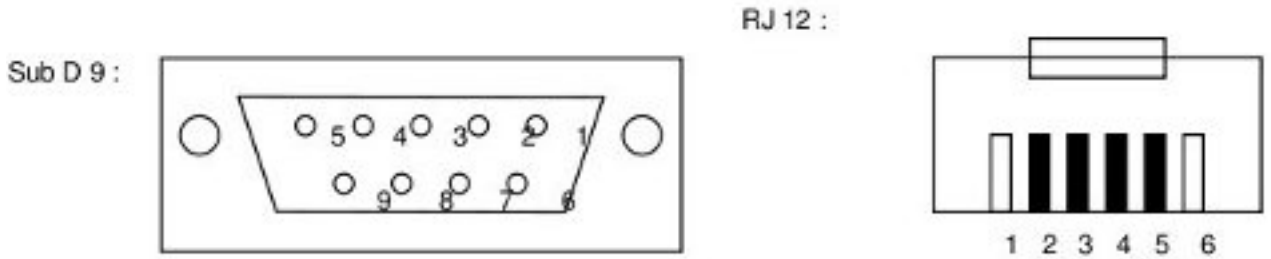

CABLE :

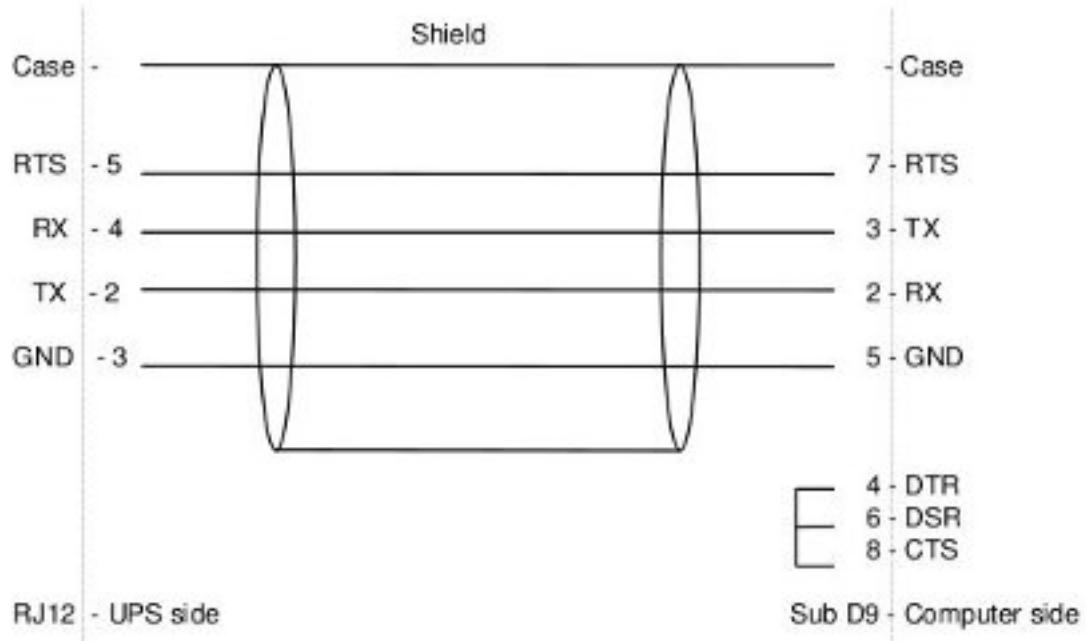

G.3.2 Powerware LanSafe

LanSafe for

3115 / 5105 / 5119 / 9110 / 9150 / 9305

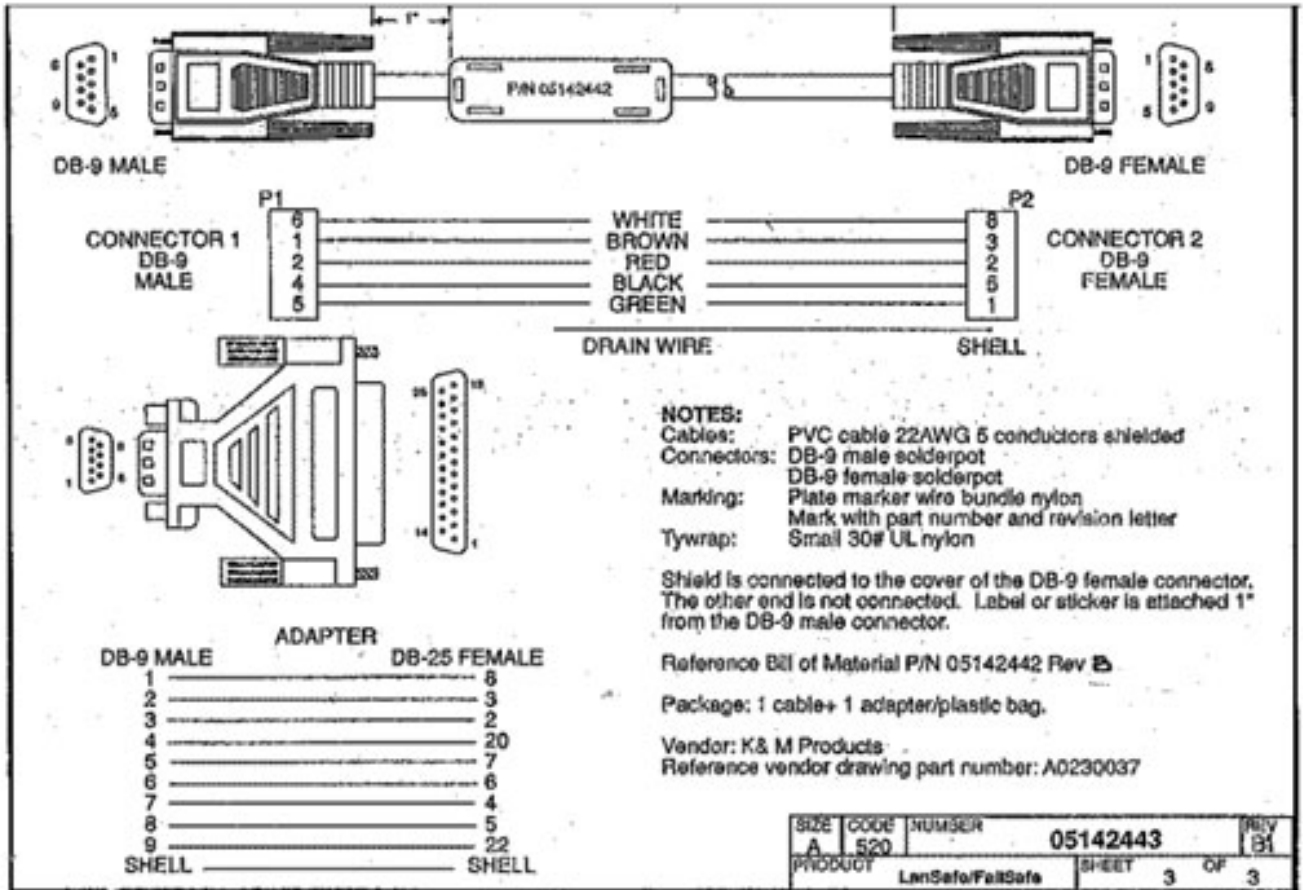

G.3.3 SOLA-330

Just uses a normal serial cable, with pin 1-1 through to 9-9.

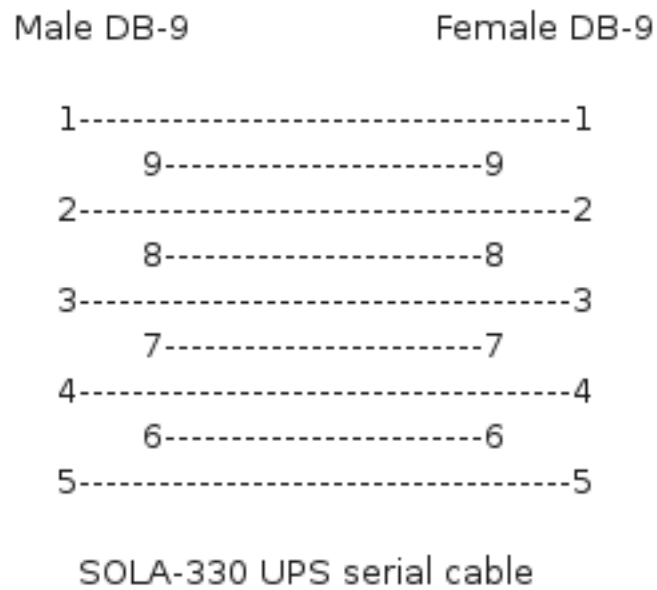

G.4 HP - Compaq

G.4.1 Older Compaq UPS Family

This cable can be used with the following models:

T700, T1000, T1500, T1500j, T700h, T1000h, T1500h, R1500, R1500j, R1500h, T2000, T2000j, T2400h, T2400h-NA, R3000 / R3000j, R3000h, R3000h-International, R3000h-NA, R6000h-NA, R6000i, R6000j.

UPS PC 9 pin connector

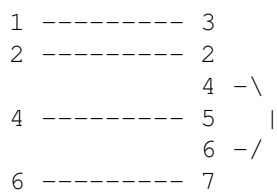

Contributed by Kjell Claesson and Arnaud Quette.

G.5 Phoenixtec (Best Power)

Many Best Power units (including the Patriot Pro II) have a female DB-9 socket with a non-standard pinout.

Signal	PC	UPS
	1,4,6	NC
TxD	2	2
RxD	3	1
GND	5	4
	7,8	NC

Sources:

- http://pinoutsguide.com/UPS/best_power_pinout.shtml
- http://lit.powerware.com/ll_download.asp?file=m_patriotproii_jan99.pdf
- Stan Gammons

G.6 Tripp-Lite

From Tripp-Lite, via Bryan Kolodziej

This cable (black 73-0844 cable) is used on various models, using the "Lan 2.2 interface" and the genericups driver (upstype=5).

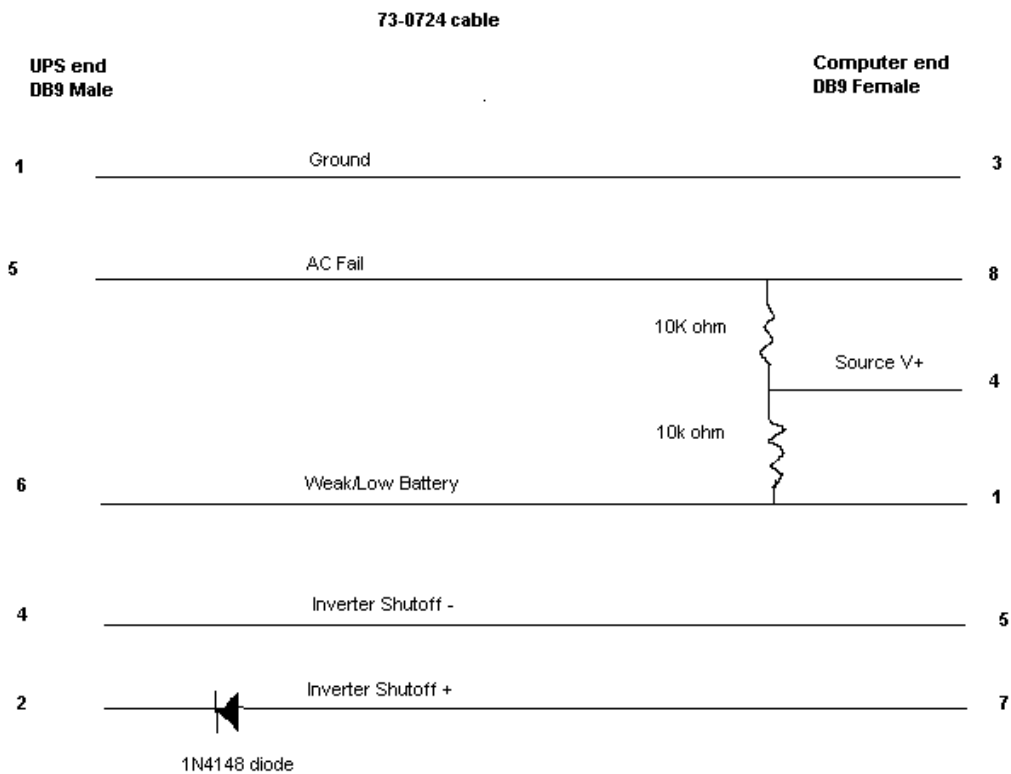

H Configure options

Note

For more information about build environment setup, see chapters below about [Configuration prerequisites](#) and [CI Farm configuration notes](#).

Two NUT websites

This version of the page reflects NUT release *v2.8.0* with codebase committed ff16dabca at 2022-04-04T11:04:28+00:00. Options, features and capabilities in current development (and future releases) are detailed on the main site and may differ from ones described here.

There are a few options reviewed below that can be given to `configure` script to tweak your compilations. See also `./configure --help` for a current and complete listing for the current version of the codebase.

H.1 Driver selection

H.1.1 Serial drivers

`--with-serial`

H.1.2 USB drivers

Build and install the serial drivers (default: yes)

`--with-usb`

Build and install the USB drivers (default: auto-detect)

Note that you need to install the `libusb` development package or files, and that both `libusb 0.1` and `1.0` are supported. In case both are available, `libusb 1.0` takes precedence, and will be used by default. It is however possible to override this default choice by explicitly calling `--with-usb=libusb-0.1` or `--with-usb=libusb-1.0`. If you do specify the version to use (or `yes` for auto-detection), this option would fail if requested (or any) `libusb` version was not found. The default `auto` value would not fail in such case.

H.1.3 SNMP drivers

`--with-snmp`

Build and install the SNMP drivers (default: auto-detect)

Note that you need to install `libsnmp` development package or files.

`--with-net-snmp-config`

In addition to the `--with-snmp` option above, this one allows to provide a custom program name (in `PATH`) or complete path-name to `net-snmp-config` (may have copies named per architecture, e.g. `net-snmp-config-32` and `net-snmp-config-64`

This may be needed on build systems which support multiple architectures, or in cases where your distribution names this program differently. With a default value of `yes` it would mean preference of this program, compared to information from `pkg-config`, if both are available.

H.1.4 XML drivers and features

`--with-neon`

Build and install the XML drivers (default: auto-detect)

Note that you need to install `neon` development package or files.

H.1.5 LLNC CHAOS Powerman driver

`--with-powerman`

Build and install Powerman PDU client driver (default: auto-detect)

This allows to interact with the Powerman daemon, and the numerous Power Distribution Units (PDU) supported by the [powerman](#) project.

Note that you need to install `powerman` development package or files.

H.1.6 IPMI drivers

```
--with-ipmi  
--with-freeipmi
```

Build and install IPMI PSU driver (default: auto-detect)

This allows to monitor numerous Power Supply Units (PSU) found on servers.

Note that you need to install freeipmi (0.8.5 or higher, for nut-scanner; and 1.0.1 or higher, for nut-ipmipsu) development package or files.

H.1.7 I2C bus drivers

```
--with-linux_i2c
```

Build and install i2c drivers (default: auto-detect)

Note that you need to install libi2c development package or files.

H.1.8 Modbus drivers

```
--with-modbus
```

Build and install modbus (Serial, TCP) drivers (default: auto-detect)

Note that you need to install libmodbus development package or files.

H.1.9 Manual selection of drivers

```
--with-drivers=<driver>,<driver>,...
```

Specify exactly which driver or drivers to build and install (this works for serial, usb, and snmp drivers, and overrides the preceding three options).

As of the time of original writing (2010), there are 46 UPS drivers available. Most users will only need one, a few will need two or three, and very few people will need all of them.

To save time during the compile and disk space later on, you can use this option to just build and install a subset of the drivers. For example, to select `mge-shut` and `usbhid-ups`, you'd do this:

```
--with-drivers=apcsmart,usbhid-ups
```

If you need to build more drivers later on, you will need to rerun `configure` with a different list. To make it build all of the drivers from scratch again, run `make clean` before starting.

H.2 Optional features

H.2.1 CGI client interface

```
--with-cgi (default: no)
```

Build and install the optional CGI programs, HTML files, and sample CGI configuration files. This is not enabled by default, as they are only useful on web servers. See [data/html/README](#) for additional information on how to set up CGI programs.

H.2.2 Pretty documentation and man pages

`--with-doc=<output-format(s)>` (default: no)

Build and install NUT documentation file(s).

This feature requires AsciiDoc 8.6.3 or newer (see <https://asciidoc.org>).

The possible documentation type values are:

- `html-single` for single page HTML,
- `html-chunked` for multi-paged HTML,
- `pdf` for a PDF file, and
- `man` for the usual manpages.

Other values understood for this option are listed below:

- If the `--with-doc` argument is passed without a list, or specifies just `=yes` or `=all`, it enables all supported formats with a `=yes` to require them.
- An (explicit!) `--with-doc=auto` argument tries to enable all supported formats with an `=auto` but should not fail the build if something can not be generated.
- A `--with-doc=no` quietly skips generation of all types of documentation, including manpages.
- `--with-doc=skip` is used to configure some of the `make distcheck*` scenarios to re-use man page files built and distributed by the main build and not waste time on re-generation of those.

Multiple documentation format values can be specified, separated with comma. Each such value can be suffixed with `=yes` to require building of this one documentation format (abort configuration if tools are missing), `=auto` to detect and enable if we can build it on this system (and not abort if we can not), and `=no` (or `=skip`) to explicitly skip generation of this document format even if we do have the tools to build it.

If a document format is mentioned in the list without a suffix, then it is treated as a `=yes` requirement.

Verbose output can be enabled using: `ASCIIDOC_VERBOSE=-v make`

Example valid formats of this flag:

- `--with-doc` without an argument, effectively same as `--with-doc=yes`
- `--with-doc=` is a valid empty list, effectively same as `--with-doc=no`
- `--with-doc=auto`
- `--with-doc=pdf,html-chunked`
- `--with-doc=man=no,pdf=auto,html-single`

H.2.3 Development files

`--with-dev` (default: no)

Build and install the upsclient and nutclient library and header files, to build further projects against NUT (such as wmNUT client and many others).

H.2.4 Options for developers

`--enable-check-NIT` (default: no)

Add `make check-NIT` to default activity of `make check` to run the NUT Integration Testing suite. This is potentially dangerous (e.g. due to port conflicts when running many such tests in same environment), so not active by default.

`--enable-maintainer-mode` (default: no)

Use `maintainer` mode to keep `Makefile.in` and `Makefile` in sync with ever-changing `Makefile.am` content after Git updates or editing.

`--enable-cppcheck` (default: no)

Activate recipes for static analysis with `cppcheck` tools (if available).

H.2.5 I want it all!

`--with-all` (no default)

Build and install all of the above (the serial, USB, SNMP, XML/HTTP and PowerMan drivers, the CGI programs and HTML files, and the `upsclient` library).

H.2.6 Networking transport security

`--with-ssl` (default: auto-detect)

`--with-nss` (default: auto-detect)

`--with-openssl` (default: auto-detect)

Enable SSL support, using either Mozilla NSS or OpenSSL.

If both are present, and nothing was specified, OpenSSL support will be preferred.

Read [docs/security.txt](#) for instructions on SSL support.

Note

Currently the two implementations differ in supported features.

H.2.7 Networking access security

`--with-wrap` (default: auto-detect)

Enable `libwrap` (`tcp-wrappers`) support.

Refer to [upsd\(8\)](#) man page for more information.

H.2.8 Networking IPv6

`--with-ipv6` (default: auto-detect)

Enable IPv6 support.

H.2.9 AVAHI/mDNS

```
--with-avahi (default: auto-detect)
```

Build and install Avahi support, to publish NUT server availability using mDNS protocol. This requires Avahi development files for the Core and Client parts.

H.2.10 LibLTDL

```
--with-libltdl (default: auto-detect)
```

Enable libltdl (Libtool dlopen abstraction) support.

This is required to build `nut-scanner` which loads third-party libraries dynamically, based on requested scanning options. This allows to build and package the tool without requiring all possible dependencies to be installed in each run-time environment.

H.3 Other configuration options

H.3.1 NUT data server port

```
--with-port=PORT
```

Change the TCP port used by the network code. Default is 3493 as registered with IANA.

Ancient versions of `upsd` used port 3305. NUT 2.0 and up use a substantially different network protocol and are not able to communicate with anything older than the 1.4 series.

If you have to monitor a mixed environment, use the last 1.4 version, as it contains compatibility code for both the old "REQ" and the new "GET" versions of the protocol.

H.3.2 Daemon user accounts

```
--with-user=<username>  
--with-group=<groupname>
```

Programs started as `root` will `setuid()` to `<username>` for somewhat safer operation. You can override this with `-u <otheruser>` in several programs, including `upsd` (and all drivers by extension), `upsd`, and `upsmo`. The "user" directive in `ups.conf` overrides this at run time for the drivers.

Note

`upsmo` does not totally drop `root` because it may need to initiate a shutdown. There is always at least a stub process remaining with `root` powers. The network code runs in another (separate) process as the new user.

The `<groupname>` is used for the permissions of some files, particularly the hotplugging rules for USB. The idea is that the device files for any UPS devices should be readable and writable by members of that group.

The default value for both the username and groupname is `nobody` (or `nogroup` on systems that have it when `configure` script runs). This was done since it's slightly better than staying around as `root`. Running things as `nobody` is not a good idea, since it's a hack for NFS access. You should create at least one separate user for this software.

If you use one of the `--with-user` and `--with-group` options, then you have to use the other one too.

See the [INSTALL.nut](#) document and the FAQ for more on this topic.

H.3.3 Syslog facility

```
--with-logfacility=FACILITY
```

Change the facility used when writing to the log file. Read the man page for `openlog` to get some idea of what's available on your system. Default is `LOG_DAEMON`.

H.4 Installation directories

```
--prefix=PATH
```

This is a fairly standard option with GNU autoconf, and it sets the base path for most of the other install directories. The default is `/usr/local/ups`, which puts everything but the state sockets in one easy place, and does not conflict with usual distribution packaging.

If you like having things to be at more of a "system" level, setting the prefix to `/usr/local` or even `/usr` might be better.

```
--exec_prefix=PATH
```

This sets the base path for architecture dependent files. By default, it is the same as `<prefix>`.

```
--sysconfdir=PATH
```

Changes the location where NUT's configuration files are stored. By default this path is `<prefix>/etc`. Setting this to `/etc/nut` or `/etc/ups` might be useful.

The `NUT_CONFPATH` environment variable overrides this at run time.

```
--sbindir=PATH  
--bindir=PATH
```

Where executable files will be installed. Files that are normally executed by root (`upsd`, `upsmmon`, `upssched`) go to `<sbindir>`, all others to `<bindir>`. The defaults are `<exec_prefix>/sbin` and `<exec_prefix>/bin` respectively.

See also `--with-drivpath` below.

```
--with-drivpath=PATH
```

The UPS drivers will be installed to this path. By default they install to `<exec_prefix>/bin`, i.e. `/usr/local/ups/bin`.

You would want a location that remains mounted when most of the system is prepared to turn off, so some distributions package NUT drivers into `/lib/nut` or similar. See [config-notes.txt](#) detailing how to set up system shutdown.

The `driverpath` global directive in the `ups.conf` file overrides this at run time.

```
--datadir=PATH
```

Change the data directory, i.e., where architecture independent read-only data is installed. By default this is `<prefix>/share`, i.e. `/usr/local/ups/share`. At the moment, this directory only holds two files — the optional `cmdvartab` and `driver.list`.

```
--mandir=PATH
```

Sets the base directories for the man pages. The default is `<prefix>/man`, i.e. `/usr/local/ups/man`.

```
--includedir=PATH
```

Sets the path for include files to be installed when `--with-dev` is selected. For example, `upsclient.h` is installed here. The default is `<prefix>/include`.

```
--libdir=PATH
```

Sets the installation path for libraries. Depending on the build configuration, this can include the `libupsclient`, `libnutclient`, `libnutclientsub`, `libnutscan` and their `pkg-config` metadata (see `--with-pkgconfig-dir` option). The default is `<exec_prefix>/lib`.

`--with-pkgconfig-dir=PATH`

Where to install `pkg-config *.pc` files. This option only has an effect if `--with-dev` is selected, and causes a `pkg-config` file to be installed in the named location. The default is `<exec_prefix>/pkgconfig`.

Use `--without-pkgconfig-dir` to disable this feature altogether.

`--with-cgipath=PATH`

The CGI programs will be installed to this path. By default, they install to `<exec_prefix>/cgi-bin`, which is usually `/usr/local/ups/cgi-bin`.

Note

If you set the prefix to something like `/usr`, you should set the `cgipath` to something else, because `/usr/cgi-bin` is pretty ugly and non-standard.

The CGI programs are not built or installed by default. Use `./configure --with-cgi` to request that they are built and installed.

`--with-htmlpath=PATH`

HTML files will be installed to this path. By default, this is `<prefix>/html`. Note that HTML files are only installed if `--with-cgi` is selected.

`--with-hotplug-dir=PATH`

Where to install Linux 2.4 hotplugging rules. The default is to use `/etc/hotplug`, if that directory exists, and to not install it otherwise. Note that this installation directory is not a subdirectory of `<prefix>` by default. When installing NUT as a non-root user, you may have to override this option.

Use `--without-hotplug-dir` to disable this feature altogether.

`--with-udev-dir=PATH`

Where to install Linux 2.6 hotplugging rules, for kernels that have the "udev" mechanism. The default is to use `/etc/udev`, if that directory exists, and to not install it otherwise. Note that this installation directory is not a subdirectory of `<prefix>` by default. When installing NUT as a non-root user, you may have to override this option.

Use `--without-udev-dir` to disable this feature altogether.

`--with-systemdsystemunitdir=PATH`

Where to install Linux `systemd` unit definitions. Useless and harmless on other OSes, including Linux distributions without `systemd`, just adding a little noise to `configure` script output.

Use `--with-systemdsystemunitdir=auto` (default) to detect the settings using `pkg-config` if possible.

Use `--with-systemdsystemunitdir(=yes)` to require detection of these settings with `pkg-config`, or fail configuration if not possible.

Use `--with-systemdsystemunitdir=no` to disable this feature altogether.

`--with-systemdshutdownmdir=PATH`

Where to install Linux systemd unit definitions for shutdown handling. Useless and harmless on other OSes, including Linux distributions without systemd, just adding a little noise to configure script output.

Use `--with-systemdshutdown-dir` to detect the settings using `pkg-config`.

Use `--with-systemdshutdown-dir=no` to disable this feature altogether.

`--with-systemdtmpfilesdir=PATH`

Where to install Linux systemd configuration for tmpfiles handling (the automatically created locations for PID, state and similar run-time files). Useless and harmless on other OSes, including Linux distributions without systemd, just adding a little noise to configure script output.

Use `--with-systemdtmpfilesdir` to detect the settings using `pkg-config`.

Use `--with-systemdtmpfilesdir=no` to disable this feature altogether.

`--with-augeas-lenses-dir=PATH`

Where to install Augeas configuration-management lenses.

Only useful and valid if you use Augeas to parse and modify configuration files. The default is to use `/usr/share/augeas/lenses` if that directory exists, and to not install it otherwise.

H.5 Directories used by NUT at run-time

`--with-pidpath=PATH`

Changes the directory where pid files are stored. By default this is `/var/run`. Certain programs like `upsmon` will leave files here.

`--with-altpidpath=PATH`

Programs that normally don't have `root` powers, like the drivers and `upsd`, write their pid files here. By default this is whatever the `statepath` (below) is, as those programs should be able to write there.

The `NUT_ALTPIDPATH` environment variable overrides this at run time.

`--with-statepath=PATH`

Change the default location of the state sockets created by the drivers to interact with the data server `upsd`. Default is `/var/state/ups`.

The `NUT_STATEPATH` environment variable overrides this at run time.

H.6 Things the compiler might need to find

H.6.1 LibGD

`--with-pkg-config`

This option allows to provide a custom program name (in `PATH`) or a complete pathname to `pkg-config` which describes `CFLAGS`, `LIBS` and possibly other build-time options in `*.pc` files, to use third-party libraries. On build systems which support multiple architectures you may also want to set `PKG_CONFIG_PATH` to match your current build.

`--with-gd-includes="-I/foo/bar"`

If you installed `libgd` in some place where your C preprocessor can't find the header files, use this switch to add additional `-I` flags.

```
--with-gd-libs="-L/foo/bar -labcd -lxyz"
```

If your copy of `libgd` isn't linking properly, use this to give the proper `-L` and `-l` flags to make it work. See `LIBS=` in `gd's Makefile`.

Note

the `--with-gd` switches are not necessary if you have `gd 2.0.8` or higher installed properly. The `gdlib-config` script or `pkg-config` manifest will be detected and used by default in that situation.

```
--with-gdlib-config
```

This option allows to provide a custom program name (in `PATH`) or a complete pathname to `gdlib-config`. This may be needed on build systems which support multiple architectures, or in cases where your distribution names this program differently.

H.6.2 LibUSB

```
--with-libusb-config
```

This option allows to provide a custom program name (in `PATH`) or a complete pathname to `libusb-config` (usually delivered only for `libusb-0.1` version, but not for `libusb-1.0`). This may be needed on build systems which support multiple architectures or provide several versions of `libusb`, or in cases where your distribution names this program differently.

H.6.3 Various

```
--with-ssl-includes, --with-usb-includes, --with-snmp-includes,  
--with-neon-includes, --with-libltdl-includes,  
--with-powerman-includes="-I/foo/bar"
```

If your system doesn't have `pkg-config` and support for any of the above libraries isn't found (but you know it is installed), you must specify the compiler flags that are needed.

```
--with-ssl-libs, --with-usb-libs, --with-snmp-libs,  
--with-neon-libs, --with-libltdl-libs  
--with-powerman-libs="-L/foo/bar -labcd -lxyz"
```

If system doesn't have `pkg-config` or it fails to provides hints for some of the settings that are needed to set it up properly and the build in defaults are not right, you can specify the correct values for your system here.

I Upgrading notes

This file lists changes that affect users who installed older versions of this software. When upgrading from an older version, be sure to check this file to see if you need to make changes to your system.

I.1 Changes from 2.7.4 to 2.8.0

- Note to distribution packagers: this version hopefully learns from many past mistakes, so many custom patches may be no longer needed. If some remain, please consider making pull requests for upstream NUT codebase to share the fixes consistently across the ecosystem. Also note that some new types of drivers (so package groups with unique dependencies) could have appeared since your packaging was written (e.g. with `modbus`), as well as new features in `systemd` integration (`nut-driver@instances` and the `nut-driver-enumerator` to manage their population), as well as updated Python 2 and Python 3 support (again, maybe dictating different package groups) as detailed below.
-

- Due to changes needed to resolve build warnings, mostly about mismatching data types for some variables, some structure definitions and API signatures of several routines had to be changed for argument types, return types, or both. Primarily this change concerns internal implementation details (may impact update of NUT forks with custom drivers using those), but a few changes also happened in header files installed for builds configured `--with-dev` and so may impact `upsclient` and `nutclient` (C++) consumers. At the very least, binaries for those consumers should be rebuilt to remain stable with NUT 2.8.0 and not mismatch int-type sizes and other arguments.
 - `libusb-1.0`: NUT now defaults to building against `libusb-1.0` API version if the configure script finds the development headers, falling back to `libusb-0.1` if not. Please report any regressions.
 - `apcupsd-ups`: When monitoring a remote `apcupsd` server, interpret "SHUTTING DOWN" as a NUT "LB" status. If you were relying on the previous behavior (for instance, in a monitor-only situation), please adjust your `upsmon` settings. Reference: <https://github.com/networkupstools/nut/issues/460>
 - `Packagers`: the `AsciiDoc` detection has been reworked to allow NUT to be built from source without requiring `asciidoc/a2x` (using pre-built man pages from the distribution tarball, for instance). Please double-check that we did not break anything (see `docs/configure.txt` for options).
 - `Driver core`: options added for standalone mode (scanning for devices without requiring `ups.conf`) - see `docs/man/nutupsdrv.txt` for details.
 - `oldmge-shut` has been removed, and replaced by `mge-shut`.
 - New drivers for devices with "Qx" (also known as "Megatec Q*") family of protocols should be developed as sub-drivers in the `nutdrv_qx` framework for USB and Serial connected devices, not as updates/clones of older e.g. `blazer` family and `bestups`. Sources, man pages and start-up messages of such older drivers were marked with "OBSOLETION WARNING".
 - `liebert-esp2`: some multi-phase variable names have been updated to match the rest of NUT.
 - `netxml-ups`: if you have old firmware, or were relying on values being off by a factor of 10, consider the `do_convert_deci` flag. See `docs/man/netxml-ups.txt` for details.
 - `snmp-ups`: detection of Net-SNMP has been updated to use `pkg-config` by default (if present), rather than `net-snmplib` script(s) as the only option available previously. The scripts tend to specify a lot of options (sometimes platform-specific) in suggested `CFLAGS` and `LIBS` compared to the packaged `pkg-config` information which also works and is more portable. If this change bites your distribution, please bring it up in <https://github.com/networkupstools/nut/issues> or better yet, post a PR. Also note that `./configure --with-netsnmplib(=yes)` should set up the preference of the detected script over `pkg-config` information, if both are available, and `--with-netsnmplib=/path/name` would as well.
 - `snmp-ups`: bit mask values for flags in earlier codebase were defined in a way that caused logically different items to have same numeric values. This was fixed to surely use different definitions (so changing numbers behind some of those macro symbols), and testing with UPS, ePDU and ATS hardware which was available did not expose any practical differences.
 - `usbhid-ups`: numeric data conversion from wire protocol to CPU representation in `GetValue()` was completely reworked, aiming to be correct on all CPU types. That said, regressions are possible and feedback is welcome.
 - `nut-scanner`: `Packagers`, take note of the changes to the library search code in `common/common.c`. Please file an issue if this does not work with your platform.
 - `dummy-ups` can now specify `mode` as a driver argument, and separates the notion of `dummy-once` (new default for `*.dev` files that do not change) vs. `dummy-loop` (legacy default for `*.seq` and others) [issue #1385]
 - Note this can break third-party test scripts which expected `*.dev` files to work as a looping sequence with a `TIMER` keywords to change values slowly; now such files should get processed to the end once. Specify `mode=dummy-loop` driver option or rename the data file used in the `port` option for legacy behavior. Use/Test-cases which modified such files content externally should not be impacted.
 - `Python`: scripts have been updated to work with Python 3 as well as 2.
 - `PyNUT` module (protocol binding) supports both Python generations.
-

- NUT-Monitor (desktop UI client) got separated into two projects: one with support for Python2 and GTK2, and another for Python3 and Qt5. On operating systems that serve both environments, either of these implementation should be usable. For distributions that deprecated and removed Python2 support, it is a point to consider in NUT packages and their build-time and installation dependencies. The historic filenames for desktop integration (NUT-Monitor script and `nut-monitor.desktop`) are still delivered, but now cover a wrapper script which detects the environment capabilities and launches the best suitable UI implementation (if both are available).
- apcsmart: updates to CS "hack" (see docs/man/apcsmart.txt for details)
- upsdebugx(): added [D#] prefix to log entries with level > 0 so if any scripts or other tools relied on parsing those messages making some assumptions, they should be updated
- upsdebugx() and related methods are now macros, optionally calling similarly named implementations like `s_upsdebugx()` as a slight optimization; this may show up in linking of binaries for some customized build scenarios
- libraries, tools and protocol now support a TRACKING ID to be used with an INSTCMD or SET VAR requests; for details see docs/net-protocol.txt and docs/sock-protocol.txt
- upsrw: display the variable type beside ENUM / RANGE
- Augeas: new `--with-augeas-lenses-dir` configure option.

1.2 Changes from 2.7.3 to 2.7.4

- scripts/systemd/nut-server.service.in: Restore systemd relationship since it was preventing upsd from starting whenever one or more drivers, among several, was failing to start
- Fix UPower device matching for recent kernels, since hiddev* devices now have class "usbmisc", rather than "usb"
- macosx-ups: the "port" driver option no longer has any effect
- Network protocol information: default to type NUMBER for variables that are not flagged as STRING . This point is subject to improvements or change in the next release 2.7.5. Refer to docs/net-protocol.txt for more information

1.3 Changes from 2.7.2 to 2.7.3

- The `nutdrv_qx(8)` driver will eventually supersede `bestups(8)`. It has been tested on a U-series Patriot Pro II. Please test the new driver on your hardware during your next maintenance window, and report any bugs.
- If you are upgrading from a new install of 2.7.1 or 2.7.2, double-check the value of POWERDOWNFLAG in `$prefix/etc/upsmon.conf` - it has been restored to `/etc/killpower` as in 2.6.5 and earlier.
- If you use upslog with a large sleep value, you may be interested in adding `killall -SIGUSR1 upslog` to any OB/OL script actions. This will force upslog to write a log entry to catch short power transients.
- Be sure that your SSL keys are readable by the NUT system user. The SSL subsystem is now initialized after upsd forks, to work around issues in the NSS library.
- The systemd nut-server.service does not Require nut-driver to be started successfully. This was previously preventing upsd startup, even for just one driver failure among many. This also matches the behavior of sysV initscripts.

1.4 Changes from 2.7.1 to 2.7.2

- upsdrvctl is now installed to `$prefix/sbin` rather than `$driverexec`. This usually means moving from `/bin` to `/sbin`, apart from few exceptions. In all cases, please adapt your scripts.
 - FreeDesktop Hardware Abstraction Layer (HAL) support was removed. Please adapt your packaging files, if you used to distribute the `nut-hal-drivers` package.
 - This is a good time to point out that for stricter packaging systems, it may be beneficial to add `--enable-option-checking=fatal` to the `./configure` command line, in order to quickly pick up any other removed option flags.
-

I.5 Changes from 2.6.5 to 2.7.1

- The `apcsmart(8)` driver has been replaced by a new implementation. There is a new parameter, `ttymode`, which may help if you have a non-standard serial port, or Windows. In case of issues with this new version, users can revert to `apcsmart-old`.
- The `nutdrv_qx(8)` driver will eventually supersede `blazer_ser` and `blazer_usb`. Options are not exactly the same, but are documented in the `nutdrv_qx` man page.
- Mozilla NSS support has been added. The OpenSSL configuration options should be unchanged, but please refer to the `upsd.conf(5)` and `upsmon.conf(5)` documentation in case we missed something.
- `upsw(8)` now prints out the maximum size of variables. Hopefully you are not parsing the output of `upsw` - it would be easier to use one of the NUT libraries, or implement the network protocol yourself.
- The jNut source is now here: <https://github.com/networkupstools/jNut>

I.6 Changes from 2.6.4 to 2.6.5

- users are encouraged to update to NUT 2.6.5, to fix a regression in `upssched`.
- `mge-shut` driver has been replaced by a new implementation (`newmge-shut`). In case of issue with this new version, users can revert to `oldmge-shut`.

I.7 Changes from 2.6.3 to 2.6.4

- users are encouraged to update to NUT 2.6.4, to fix `upsd` vulnerability (CVE-2012-2944: `upsd` can be remotely crashed).
- users of the `bestups` driver are encouraged to switch to `blazer_ser`, since `bestups` will soon be deprecated.

I.8 Changes from 2.6.2 to 2.6.3

- nothing that affects upgraded systems.

I.9 Changes from 2.6.1 to 2.6.2

- `apcsmart` driver has been replaced by a new implementation. In case of issue with this new version, users can revert to `apcsmart-old`.

I.10 Changes from 2.6.0 to 2.6.1

- nothing that affects upgraded systems.

I.11 Changes from 2.4.3 to 2.6.0

- users of the `megatec` and `megatec_usb` drivers must respectively switch to `blazer_ser` and `blazer_usb`.
- users of the `liebertgxt2` driver are advised that the driver name has changed to `liebert-esp2`.

I.12 Changes from 2.4.2 to 2.4.3

- nothing that affects upgraded systems.
-

I.13 Changes from 2.4.1 to 2.4.2

- The default subdriver for the blazer_usb driver USB id 06da:0003 has changed. If you use such a device and it is no longer working with this driver, override the *subdriver* default in *ups.conf* (see man 8 blazer).
- NUT ACL and the allowfrom mechanism has been replaced in 2.4.0 by the LISTEN directive and tcp-wrappers respectively. This information was missing below, so a double note has been added.

I.14 Changes from 2.4.0 to 2.4.1

- nothing that affects upgraded systems.

I.15 Changes from 2.2.2 to 2.4.0

- The nut.conf file has been introduced to standardize startup configuration across the various systems.
- The cpsups and nitram drivers have been replaced by the powerpanel driver, and removed from the tree. The cyberpower driver may suffer the same in the future.
- The al175 and energizerups drivers have been removed from the tree, since these were tagged broken for a long time.
- Developers of external client application using libupsclient must rename their "UPSCONN" client structure to "UPSCONN_t".
- The upsd server will now disconnect clients that remain silent for more than 60 seconds.
- The files under scripts/python/client are distributed under GPL 3+, whereas the rest of the files are distributed under GPL 2+. Refer to COPYING for more information.
- The generated udev rules file has been renamed with dash only, no underscore anymore (ie 52-nut-usbups.rules instead of 52_nut-usbups.rules)

I.16 Changes from 2.2.1 to 2.2.2

- The configure option "--with-lib" has been replaced by "--with-dev". This enable the additional build and distribution of the static version of libupsclient, along with the pkg-config helper and manual pages. The default configure option is to distribute only the shared version of libupsclient. This can be overridden by using the "--disable-shared" configure option (distribute static only binaries).
- The UPS poweroff handling of the usbhid-ups driver has been reworked. Though regression is not expected, users of this driver are encouraged to test this feature by calling "upsmon -c fsd" and report any issue on the NUT mailing lists.

I.17 Changes from 2.2.0 to 2.2.1

- nothing that affects upgraded systems. (The below message is repeated due to previous omission)
- Developers of external client application using libupsclient are encouraged to rename their "UPSCONN" client structure to "UPSCONN_t" since the former will disappear by the release of NUT 2.4.

I.18 Changes from 2.0.5 to 2.2.0

- users of the newhidups driver are advised that the driver name has changed to usbhid-ups.
 - users of the hidups driver must switch to usbhid-ups.
 - users of the following drivers (powermust, blazer, fentonups, mustek, esupssmart, ippon, sms) must switch to megatec, which replaces all these drivers. Please refer to doc/megatec.txt for details.
-

- users of the mge-shut driver are encouraged to test newmge-shut, which is an alternate driver scheduled to replace mge-shut,
- users of the cpsups driver are encouraged to switch to powerpanel which is scheduled to replace cpsups,
- packagers will have to rework the whole nut packaging due to the major changes in the build system (completely modified, and now using automake). Refer to packaging/debian/ for an example of migration.
- specifying *-a <id>* is now mandatory when starting a driver manually, ie not using upsdrvctl.
- Developers of external client application using libupsclient are encouraged to rename the "UPSCONN" client structure to "UPSCONN_t" since the former will disappear by the release of NUT 2.4.

I.19 Changes from 2.0.4 to 2.0.5

- users of the newhidups driver: the driver is now more strict about refusing to connect to unknown devices. If your device was previously supported, but fails to be recognized now, add *productid=XXXX* to ups.conf. Please report the device to the NUT developer's mailing list.

I.20 Changes from 2.0.3 to 2.0.4

- nothing that affects upgraded systems.
- users of the following drivers (powermust, blazer, fentonups, mustek, esupssmart, ippon, sms, masterguard) are encouraged to switch to megatec, which should replace all these drivers by nut 2.2. For more information, please refer to doc/megatec.txt

I.21 Changes from 2.0.2 to 2.0.3

- nothing that affects upgraded systems.
- hidups users are encouraged to switch to newhidups, as hidups will be removed by nut 2.2.

I.22 Changes from 2.0.1 to 2.0.2

- The newhidups driver, which is the long run USB support approach, needs hotplug files installed to setup the right permissions on device file to operate. Check newhidups manual page for more information.

I.23 Changes from 2.0.0 to 2.0.1

- The cyberpower1100 driver is now called cpsups since it supports more than just one model. If you use this driver, be sure to remove the old binary and update your ups.conf *driver=* setting with the new name.
- The upsstats.html template page has been changed slightly to reflect better HTML compliance, so you may want to update your installed copy accordingly. If you've customized your file, don't just copy the new one over it, or your changes will be lost!

I.24 Changes from 1.4.0 to 2.0.0

- The sample config files are no longer installed by default. If you want to install them, use *make install-conf* for the main programs, and *make install-cgi-conf* for the CGI programs.
- ACCESS is no longer supported in upsd.conf. Use ACCEPT and REJECT. Old way:

```
ACCESS grant all adminbox
ACCESS grant all webserver
ACCESS deny all all
```

New way:

```
ACCEPT adminbox
ACCEPT webserver
REJECT all
```

Note that ACCEPT and REJECT can take multiple arguments, so this will also work:

```
ACCEPT adminbox webserver
REJECT all
```

- The drivers no longer support `sddelay` in `ups.conf` or `-d` on the command line. If you need a delay after calling `upsdrvctl shutdown`, add a call to `sleep` in your shutdown script.
- The templates used by `upsstats` have changed considerably to reflect the new variable names. If you use `upsstats`, you will need to install new copies or edit your existing files to use the new names.
- Nobody needed UDP mode, so it has been removed. The only users seemed to be a few people like me with ancient `asapm-ups` binaries. If you really want to run `asapm-ups` again, bug me for the new patch which makes it work with `upsclient`.
- `make install-misc` is now `make install-lib`. The `misc` directory has been gone for a long time, and the target was ambiguous.
- The `newapc` driver has been renamed to `apcsmart`. If you previously used `newapc`, make sure you delete the old binary and fix your `ups.conf`. Otherwise, you may run the old driver from 1.4.
 - File trimmed here on changes from 1.2.2 to 1.4.0 *

For information before this point, start with version 2.4.1 and work back.

J Project history

Two NUT websites

This version of the page reflects NUT release `v2.8.0` with codebase committed `ff16dabca` at `2022-04-04T11:04:28+00:00`. Options, features and capabilities in current development (and future releases) are detailed on the main site and may differ from ones described here.

This page is an attempt to document how everything came together.

The Network UPS Tools team would like to warmly thank Russell Kroll.

Russell initially started this project, maintaining and improving it for over 8 years (1996 — mid 2005).

J.1 Prototypes and experiments

J.1.1 May 1996: early status hacks

APC's Powerchute was running on `kadets.d20.co.edu` (a BSD/OS box) with SCO binary emulation. Early test versions ran in `cron`, pulled status from the log files and wrote them to a `.plan` file. You could see the results by fingering `pwrchute@kadets.d20.co.edu` while it lasted:

```
Last login Sat May 11 21:33 (MDT) on tty0 from intrepid.rmi.net
Plan:
Welcome to the UPS monitor service at kadets.d20.co.edu.
The Smart-UPS attached to kadets generated a report at 14:24:01 on 05/17/96.
During the measured period, the following data points were taken:
Voltage ranged from 115.0 VAC to 116.3 VAC.
```

```
The UPS generated 116.3 VAC at 60.00 Hz.
The battery level was at 27.60 volts.
The load placed on the UPS was 024.9 percent.
UPS temperature was measured at 045.0 degrees Celsius.
Measurements are taken every 10 minutes by the upsd daemon.
This report is generated by a script written by Russell Kroll<rkroll@kadets>.
Modified for compatibility with the BSD/OS cron daemon by Neil Schroeder
```

This same status data could also be seen with a web browser, since we had rigged up a CGI wrapper script which called finger.

J.1.2 January 1997: initial protocol tests

Initial tests with a freestanding non-daemon program provided a few basic status registers from the UPS. The 940-0024C cable was not yet understood, so this happened over the [attachment:apcevilhack.jpg evil two-wire serial hack].

```
Communicating with SMART-UPS 700 S/N WS9643050926 [10/17/96]
Input voltage range: 117.6 VAC - 118.9 VAC
Load is 010.9% of capacity, battery is charged to 100.0% of capacity
```

Note that today's apcsmart driver still displays the serial number when it starts, since it is derived from this original code.

J.1.3 September 1997: first client/server code

The first split daemon/client code was written. upsd spoke directly to the UPS (APC Smart models only) and communicated with upsc by sending binary structures in UDP datagrams.

The first CGI interface existed, but it was all implemented with shell scripts. The main script would call upsc to retrieve status values. Then it would cat a template file through sed to plug them into the page.

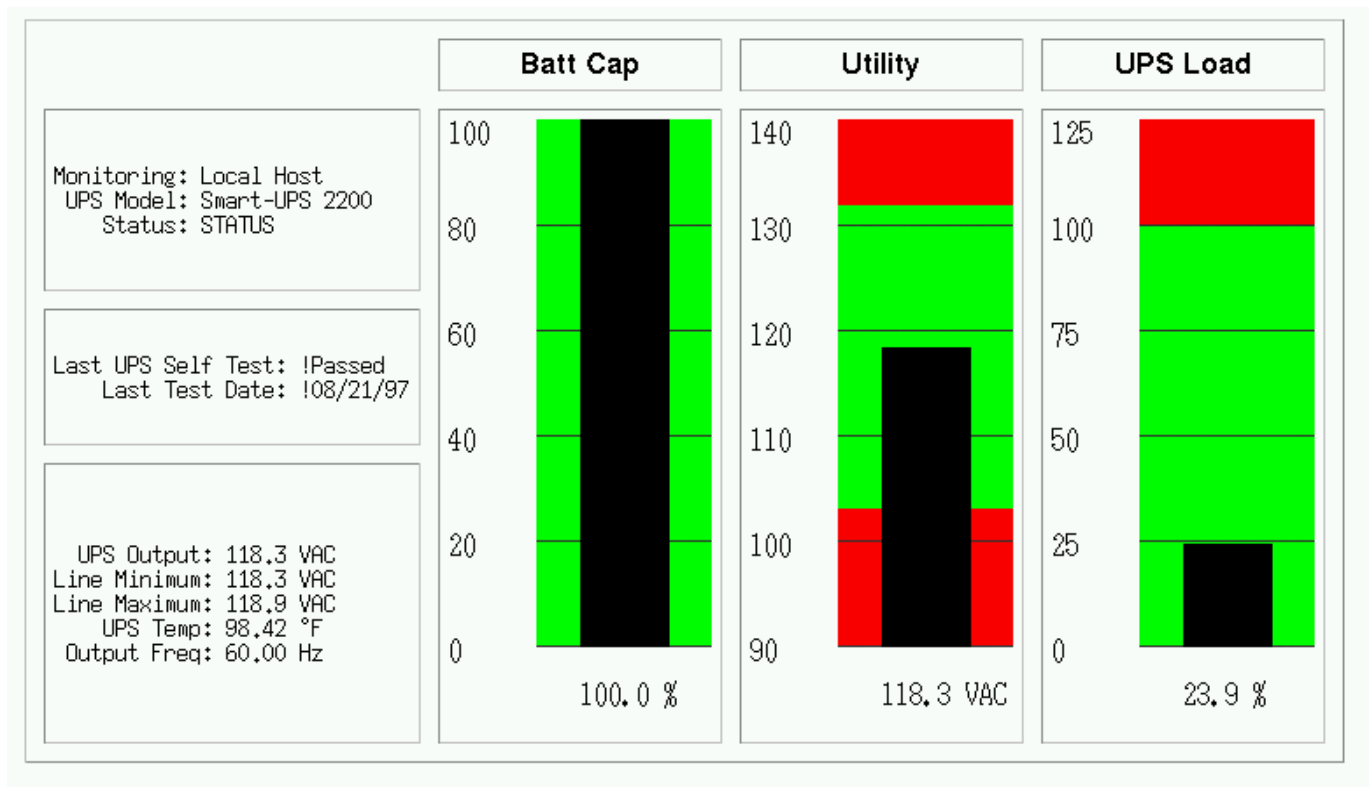

upsstats actually has since returned to using templates, despite having a period in the middle when it used hardcoded HTML.

The images were also created with shell scripts. Each script would call `upsc` to get the right value (utility, upload, battcap). It then took the value, plugged it into a command file with `sed`, and passed that into `fly`, a program which used an interpreted language to create images. `fly` actually uses `gd`, just like `upsimage` does today.

This code later evolved into Smart UPS Tools 0.10.

J.2 Smart UPS Tools

J.2.1 March 1998: first public release

Version 0.10 was released on March 10, 1998. It used the same design as the pre-release prototype. This made expansion difficult as the binary structure used for network communications would break any time a new variable was added. Due to byte-ordering and struct alignment issues, the code usually couldn't talk over the network to a system with a different architecture. It was also hopelessly bound to one type of UPS hardware.

Five more releases followed with this design followed. The last was 0.34, released October 27, 1998.

J.2.2 June 1999: Redesigned, rewritten

Following a long period of inactivity and two months of prerelease testing versions, 0.40.0 was released on June 5, 1999. It featured a complete redesign and rewrite of all of the code. The layering was now in three pieces, with the single driver (`smartups`) separate from the server (`upsd`).

Clients remained separate as before and still used UDP to talk to the server, but they now used a text-based protocol instead of the brittle binary structs. A typical request like "REQ UTILITY" would be answered with "ANS UTILITY 120.0".

The `ups-trust425-625` driver appeared shortly after the release of 0.40.0, marking the first expansion beyond APC hardware.

Over the months that followed, the `backupspro` driver would be forked from the `smartups` driver to handle the APC Back-UPS Pro line. Then the `backups` driver was written to handle the APC Back-UPS contact-closure models. These drivers would later be renamed and recombined, with `smartups` and `backupspro` becoming `apcsmart`, and `backups` became `genericups`.

The drivers stored status data in an array. At first, they passed this data to `upsd` by saving it to a file. `upsd` would reread this file every few seconds to keep a copy for itself. This was later expanded to allow shared memory mode, where only a stub would remain on the disk. The drivers and server then passed data through the shared memory space.

`upsd` picked up the ability to monitor multiple drivers on the system, and the "upsname@hostname" scheme was born. Access controls were added, and then the network code was expanded to allow TCP communications, which at this point were on port 3305.

J.3 Network UPS Tools

J.3.1 September 1999: new name, new URL

Several visitors to the web page and subscribers to the mailing lists provided suggestions to rename the project. The old name no longer accurately described it, and it was perilously close to APC's "Smart-UPS" trademark. Rather than risk problems in the future, the name was changed. Kern Sibbald provided the winner: Network UPS Tools, which captures the essence of the project and makes for great short tarball filenames: `nut-x.y.z.tar.gz`.

The new name was first applied to 0.42.0, released October 31, 1999. This is also when the web pages moved from the old <http://www.exploits.org/~rkroll/smartupstools/> URL to the replacement at <http://www.exploits.org/nut> to coincide with the name change.

More drivers were written and the hardware support continued to grow. `upsmon` picked up the concepts of what is now known as "primary" and "secondary", and could now handle environments where multiple systems get power from a single UPS.

Manager mode was added to allow changing the value of read/write variables in certain UPS models.

J.3.2 June 2001: common driver core

Up to this point, all of the drivers compiled into freestanding programs, each providing their own implementation of `main()`. This meant they all had to check the incoming arguments and act uniformly. Unfortunately, not all of the programs behaved the same way, and it was hard to document and use consistently. It also meant that startup scripts had to be edited depending on what kind of hardware was attached.

Starting in 0.45.0, released June 11, 2001, there was a new common core for all drivers called `main.c`. It provided the main function and called back to the `upsdrv_*` functions provided by the hardware-specific part of the drivers. This allowed driver authors to focus on the UPS hardware without worrying about the housekeeping stuff that needs to happen.

This new design provided an obvious way to configure drivers from one file, and so `ups.conf` was born. This eventually spawned `upsdrvctl`, and now all drivers based on this common core could be started or stopped with one command. Startup scripts now could contain "upsdrvctl start", and it didn't matter what kind of hardware or how many UPSes you had on one system.

Interestingly, at the end of this month, Arnaud Quette entered the UPS world, as a subcontractor of the now defunct MGE UPS SYSTEMS. This marked the start of a future successful collaboration.

J.3.3 May 2002: casting off old drivers, IANA port, towards 1.0

During the 0.45.x series, both the old standalone drivers and the ones which had been converted to the common core were released together. Before the release of 0.50.0 on May 24, 2002, all of the old drivers were removed. While this shrank the list of supported hardware, it set the precedent for removing code which isn't receiving regular maintenance. The assumption is that the code will be brought back up to date by someone if they actually need it. Otherwise, it's just dead weight in the tree.

This change meant that all remaining drivers could be controlled with the `upsdrvctl` and `ups.conf`, allowing the documentation to be greatly simplified. There was no longer any reason to say "do this, unless you have this driver, then do this".

IANA granted an official port number to the project, and the network code switched to port 3493. It had previously been on 3305 which is assigned to `odette-ftp`. 3305 was probably picked in 1997 because it was the fifth project to spawn from some common UDP server code.

After 0.50.1, the 0.99 tree was created to provide a tree which would receive nothing but bug fixes in preparation for the release of 1.0. As it turned out, very few things required fixing, and there were only three releases in this tree.

J.4 Leaving 0.x territory

J.4.1 August 2002: first stable tree: NUT 1.0.0

After nearly 5 years of having a 0.x version number, 1.0.0 was released on August 19, 2002. This milestone meant that all of the base features that you would expect to find were intact: good hardware support, a network server with security controls, and system shutdowns that worked.

The design was showing signs of wear from the rapid expansion, but this was intentionally ignored for the moment. The focus was on getting a good version out that would provide a reasonable base while the design issues could be addressed in the future, and I'm confident that we succeeded.

J.4.2 November 2002: second stable tree: NUT 1.2.0

One day after the release of 1.0.0, 1.1.0 started the new development tree. During that development cycle, the CGI programs were rewritten to use template files instead of hard-coded HTML, thus bringing back the flexibility of the original unreleased prototype from 5 years before. The `multimon` was removed from the tree, as the new `upsstats` could do both jobs by loading different templates.

A new client library called `upsclient` was created, and it replaced `upsfetch`. This new library only supported TCP connections, and used an opaque context struct to keep state for each connection. As a result, client programs could now do things that used multiple connections without any conflicts. This was done primarily to allow OpenSSL support, but there were other benefits from the redesign.

upsd and the clients could now use OpenSSL for basic authentication and encryption, but this was not included by default. This was provided as a bonus feature for those users who cared to read about it and enable the option, as the initial setup was complex.

After the 1.1 tree was frozen and deemed complete, it became the second stable tree with the release of 1.2.0 on November 5, 2002.

J.4.3 April 2003: new naming scheme, better driver glue, and an overhauled protocol

Following an extended period with no development tree, 1.3.0 got things moving again on April 13, 2003. The focus of this tree was to rewrite the driver-server communication layer and replace the static naming scheme for variables and commands.

Up to this point, all variables had names like STATUS, UTILITY, and OUTVOLT. They had been created as drivers were added to the tree, and there was little consistency. For example, it probably should have been INVOLT and OUTVOLT, but there was no OUTVOLT originally, so UTILITY was all we had. This same pattern repeated with ACFREQ— is it incoming or outgoing? —and many more.

To solve this problem, all variables and commands were renamed to a hierarchical scheme that had obvious grouping. STATUS became ups.status. UTILITY turned into input.voltage, and OUTVOLT is output.voltage. ACFREQ is input.frequency, and the new output.frequency is also now supported. Every other variable or command was renamed in this fashion.

These variables had been shared between the drivers and upsd as values. That is, for each name like STATUS, there was a #define somewhere in the tree with an INFO_ prefix that gave it a number. INFO_STATUS was 0x0006, INFO_UTILITY was 0x0004, and so on, with each name having a matching number. This number was stored in an int within a structure which was part of the array that was either written to disk or shared memory.

That structure had several restrictions on expansion and was dropped as the data sharing method between the drivers and the server. It was replaced by a new system of text-based messages over Unix domain sockets. Drivers now accepted a short list of commands from upsd, and would push out updates asynchronously. upsd no longer had to poll the state files or shared memory. It could just select all of the driver and client fds and act on events.

At the same time, the network protocol on port 3493 was overhauled to take advantage of the new naming scheme. The existing "REQ STATUS@su700", "ANS STATUS@su700 OL" scheme was showing signs of age, and it really only supported the UPS name (@su700) as an afterthought. The new protocol would now use commands like GET and LIST, leading to exchanges like "GET VAR su700 ups.status" and "VAR su700 ups.status OL". These responses contain enough data to stand alone, so clients can now handle them asynchronously.

J.4.4 July 2003: third stable tree: NUT 1.4.0

On July 25, 2003, 1.4.0 was released. It contained support for both the old "REQ" style protocol (with names like STATUS), and the new "GET" style protocol (with names like ups.status). This tree is provided to bridge the gap between all of the old releases and the upcoming 2.0.

2.0 will be released without support for the old REQ/STATUS protocol. The hope is that client authors and those who have implemented their own monitoring software will use the 1.4 cycle to change to the new protocol. The 1.4 releases contain a lot of compatibility code to make sure both work at the same time.

J.4.5 July 2003: pushing towards 2.0

1.5.0 forked from 1.4.0 and was released on July 29, 2003. The first changes were to throw out anything which was providing compatibility with the older versions of the software. This means that 1.5 and the eventual 2.0 will not talk to anything older than 1.4.

This tree continues to evolve with new serial routines for the drivers which are intended to replace the aging upscommon code which dates back to the early 0.x releases. The original routines would call alarm and read in a tight loop while fetching characters. The new functions are much cleaner, and wait for data with select. This makes for much cleaner code and easier strace/ktrace logs, since the number of syscalls has been greatly reduced.

There has also been a push to make sure the data from the UPS is well-formed and is actually usable before sending updates out to upsd. This started during 1.3 as drivers were adapted to use the dstate functions and the new variable/command names. Some

drivers which were not converted to the new naming scheme or didn't do sanity checks on the incoming UPS data from the serial port were dropped from the tree.

This tree was released as 2.0.0.

J.5 networkupstools.org

J.5.1 November 2003: a new URL

The bandwidth demands of a project like this have slowly been forcing me to offload certain parts to other servers. The download links have pointed offsite for many months, and other large things like certain UPS protocols have followed. As the traffic grows, it's clear that having the project attached to exploits.org is not going to work.

The solution was to register a new domain and set up mirrors. There are two initial web servers, with more on the way. The main project URL has changed from <http://www.exploits.org/nut/> to <http://www.networkupstools.org>. The actual content is hosted on various mirrors which are updated regularly with rsync, so the days of dribbling bits through my DSL should be over.

This is also when all of the web pages were redesigned to have a simpler look with fewer links on the left side. The old web pages used to have 30 or more links on the top page, and most of them vanished when you dropped down one level. The links are now constant on the entire site, and the old links now live in their own groups in separate directories.

J.6 Second major version

J.6.1 March 2004: NUT 2.0.0

NUT 2.0.0 arrived on March 23, 2004. The jump to version 2 shows the difference in the protocols and naming that happened during the 1.3 and 1.5 development series. 2.0 no longer ships with backwards compatibility code, so it's smaller and cleaner than 1.4.

J.7 The change of leadership

J.7.1 February 2005: NUT 2.0.1

The year 2004 was marked by a release slowdown, since Russell was busy with personal subjects. But the patches queue was still growing quickly.

At that time, the development process was still centralized. There was no revision control system (like the current Subversion repository), nor trackers to interact with NUT development. Russell was receiving all the patches and requests, and doing all the work on his own, including releases.

Russell was more and more thinking about giving the project leadership to Arnaud Quette, which finally happened with the 2.0.1 release in February 2005.

This marked a new era for NUT. . .

First, Arnaud aimed at opening up the development by creating a project on the [Debian Alioth Forge](#). This allowed to build the team of hackers that Russell dreamed about. It also allows to ensure NUT's continuation, whatever happens to the leader. And that would most of all boost the projects contributions.

K Prerequisites for building NUT on different OSes

Two NUT websites

This version of the page reflects NUT release *v2.8.0* with codebase committed ff16dabca at 2022-04-04T11:04:28+00:00

Options, features and capabilities in current development (and future releases) are detailed on the main site and may differ from ones described here.

This chapter aims to list packages with the tools needed on a freshly minimally deployed worker to build as many targets of NUT recipes as possible, mainly the diverse driver and documentation types.

NUT codebase generally should not depend on particular operating system or kernel technology and version, and with the operating systems listed below one can benefit from use of containers (jails, zones) to build and test against numerous OS distributions on one physical or virtual machine, e.g. to cover non-regression with older tool kits while taking advantage of new releases.

- For Linux systems, we have notes on [Setting up the multi-arch Linux LXC container farm for NUT CI](#)

Some of the below are alternatives, e.g. compiler toolkits (gcc vs. clang) or SSL implementations (OpenSSL vs Mozilla NSS) —no problem installing both, at a disk space cost.

Note

Some NUT branches may need additional or different software versions that are not yet included into `master` branch dependencies, e.g. the DMF (Dynamic Mapping Files) sub-project needs LUA 5.1.

More packages and/or system setup may be needed to actually run NUT with all features enabled; chapters below concern just with building it.

K.1 General call to Test the ability to configure and build

Check out from git, generate files and configure to tailor to your build environment, and build some tests:

```

:; mkdir -p nut && cd nut && \
    git clone https://github.com/networkupstools/nut/ -b master .
:; ./autogen.sh && \
    ./configure --with-doc=all --with-all --with-cgi && \
    make all && make check && make spellcheck

```

You can toggle some `configure` options to check different dependency variants, e.g. `--with-ssl=nss` vs. `--with-ssl=openssl`

For reproducible runs of various pre-sets of configuration during development, take a look at `ci_build.sh` script and different `BUILD_TYPE` (and other) environment variable settings that it supports. A minimal run with it is just to call the script, e.g.:

```

:; mkdir -p nut && cd nut && \
    git clone https://github.com/networkupstools/nut/ -b fightwarn .
:; ./ci_build.sh

```

Note

To build older releases, such as "vanilla" NUT 2.7.4 and older, you may need to address some nuances:

- Ensure that `python` in `PATH` points to a `python-2.x` implementation (`master` branch is fixed to work with python 2 and 3)
 - Ensure that `bash` is your user and maybe system shell (or ensure the generated `configure` script gets interpreted by it)
 - Generally you may have better results with GNU Make newer than 3.81 than with other make implementations; however, builds are regularly tested by CI with Sun `dmake` and BSD `make` as well, so recipes should not expect GNU-only syntax and constructs to work
 - Parallel builds should be okay in current development version and since NUT 2.8.0 (is a bug to log and fix, if not), but they may be failure-prone in 2.7.4 and earlier releases
-

For intensive rebuilds, `ccache` is recommended.

K.2 Build prerequisites to make NUT from scratch on various Operating Systems

K.2.1 Debian 10/11

Being a popular baseline among Linux distributions, Debian is an important build target. Related common operating systems include Ubuntu and customized distros for Raspberry Pi, Proxmox, as well as many others.

The package list below should largely apply to those as well, however note that some well-known package names tend to differ. A few of those are noted below.

Note

While Debian distros I've seen (8 to 11) provide a "libusb-dev" for libusb-0.1 headers, the binary library package name is specifically versioned package by default of the current release (e.g. "libusb-0.1-4"), while names of both the library and development packages for libusb-1.0 must be determined with:

```
;; apt-cache search 'libusb.*1\|.0.*'
```

yielding e.g. "libusb-1.0-0-dev" (string name was seen with different actual package source versions on both Debian 8 "Jessie" and Debian 11 "Buster").

Debian-like package installations commonly start with an update of metadata about recently published package revisions:

```
;; apt-get update

# NOTE: Older Debian-like distributions may lack a "libtool-bin"
;; apt-get install \
  ccache time \
  git python perl curl \
  make autoconf automake libltdl-dev libtool-bin libtool \
  valgrind \
  cppcheck \
  pkg-config \
  gcc g++ clang

# NOTE: For python, you may eventually have to specify a variant like this
# (numbers depending on default or additional packages of your distro):
#   ;; apt-get install python2 python2.7 python-is-python2
# and/or:
#   ;; apt-get install python3 python3.9
# You can find a list of what is (pre-)installed with:
#   ;; dpkg -l | grep -Ei 'perl|python'

# For spell-checking, highly recommended if you would propose pull requests:
;; apt-get install \
  aspell aspell-en

# For other doc types (man-page, PDF, HTML) generation - massive packages (TEX, X11):
;; apt-get install \
  asciidoc source-highlight python3-pygments dblatex

# For CGI graph generation - massive packages (X11):
;; apt-get install \
  libgd-dev

# NOTE: Some older Debian-like distributions, could ship "libcrypto-dev"
# and/or "openssl-dev" instead of "libssl-dev" by its modern name
;; apt-get install \
  libcppunit-dev \
  libssl-dev libnss3-dev \
  augeas-tools libaugeas-dev augeas-lenses \
```

```

libusb-dev libusb-1.0-0-dev \
libi2c-dev \
libmodbus-dev \
libsnmp-dev \
libpowerman0-dev \
libfreeipmi-dev libipmimonitoring-dev \
libavahi-common-dev libavahi-core-dev libavahi-client-dev
# For libneon, see below

:; apt-get install \
    lua5.1-dev

:; apt-get install \
    bash dash ksh busybox

```

Alternatives that can depend on your system's other packaging choices:

```

:; apt-get install libneon27-dev
# ... or
:; apt-get install libneon27-gnutls-dev

```

Over time, Debian and Ubuntu had different packages and libraries providing the actual methods for I2C; if your system lacks the `libi2c` (and so fails to `./configure --with-all`), try adding the following packages:

```

:; apt-get install build-essential git-core libi2c-dev i2c-tools lm-sensors

```

For cross-builds (note that not everything supports multilib approach, limiting standard package installations to one or another implementation; in that case local containers each with one ARCH may be a better choice, with `qemu-user-static` playing a role to "natively" run the other-ARCH complete environments):

```

:; apt-get install \
    gcc-multilib g++-multilib \
    crossbuild-essential \
    gcc-10:armhf gcc-10-base:armhf \
    qemu-user-static

```

Note

For Jenkins agents, also need to `apt-get install openjdk-11-jdk-headless` (technically, needs at least JRE 8+). You may have to ensure `/proc` is mounted in the target chroot (or do this from the running container).

K.2.2 CentOS 7

CentOS is another popular baseline among Linux distributions, being a free derivative of the RedHat Linux, upon which many other distros are based as well. These systems typically use the RPM package manager, using directly `rpm` command, or `yum` or `dnf` front-ends depending on their generation.

For CentOS 7 it seems that not all repositories are equally good; some of the software below is only served by EPEL (Extra Packages for Enterprise Linux), as detailed at:

- <https://docs.fedoraproject.org/en-US/epel/>
- <https://www.redhat.com/en/blog/whats-epel-and-how-do-i-use-it>
- <https://pkgs.org/download/epel-release>

You may have to specify a mirror as the `baseurl` in a `/etc/yum.repos.d/...` file (as the aged distributions become less served by mirrors), such as:

- https://www.mirrorservice.org/sites/dl.fedoraproject.org/pub/epel/7/x86_64/

```
# e.g. for CentOS7 currently:
:; yum install https://download-ib01.fedoraproject.org/pub/epel/7/x86_64/Packages/e/epel- ↵
    release-7-14.noarch.rpm

# And edit /etc/yum.repos.d/epel.repo to uncomment and set the baseurl=...
# lines, and comment away the mirrorlist= lines (if yum hiccups otherwise)
```

General developer system helpers mentioned in `ci-farm-lxc-setup.txt`:

```
:; yum update

:; yum install \
    sudo vim mc p7zip pigz pbzip2
```

Note

Below we request to install generic `python` per system defaults. You may request specifically `python2` or `python3` (or both): current NUT should be compatible with both (2.7+ at least).

Note

On CentOS, `libusb` means 0.1.x and `libusbx` means 1.x.x API version.

Note

On CentOS, it seems that development against `libi2c/smbus` is not supported. Neither the suitable devel packages were found, nor `i2c`-based drivers in distro packaging of NUT. Resolution and doc PRs are welcome.

```
:; yum install \
    ccache time \
    file systemd-devel \
    git python perl curl \
    make autoconf automake libtool-ltdl-devel libtool \
    valgrind \
    cppcheck \
    pkgconfig \
    gcc gcc-c++ clang

# NOTE: For python, you may eventually have to specify a variant like this
# (numbers depending on default or additional packages of your distro):
# :; yum install python-2.7.5
# and/or:
# :; yum install python3 python3-3.6.8
# You can find a list of what is (pre-)installed with:
# :; rpm -qa | grep -Ei 'perl|python'

# For spell-checking, highly recommended if you would propose pull requests:
:; yum install \
    aspell aspell-en

# For other doc types (man-page, PDF, HTML) generation - massive packages (TEX, X11):
:; yum install \
    asciidoc source-highlight python-pygments dblatex

# For CGI graph generation - massive packages (X11):
:; yum install \
```

```

gd-devel

# NOTE: "libusbx" is the CentOS way of naming "libusb-1.0"
# vs. the older "libusb" as the package with "libusb-0.1"
;; yum install \
    cppunit-devel \
    openssl-devel nss-devel \
    augeas augeas-devel \
    libusb-devel libusbx-devel \
    i2c-tools \
    libmodbus-devel \
    net-snmp-devel \
    powerman-devel \
    freeipmi-devel \
    avahi-devel \
    neon-devel
#?# is python-augeas needed? exists at least...
#?# no (lib)i2c-devel ...
#?# no (lib)ipmimonitoring-devel ... would "freeipmi-ipmidetected" cut it at least for run- ←
time?

# Some NUT code related to lua may be currently limited to lua-5.1
# or possibly 5.2; the former is default in CentOS 7 releases...
;; yum install \
    lua-devel

;; yum install \
    bash dash ksh

```

Note

busybox is not packaged for CentOS 7 release; a static binary can be downloaded if needed. For more details, see <https://unix.stackexchange.com/questions/475584/cannot-install-busybox-on-centos>

CentOS packaging for 64-bit systems delivers the directory for dispatching compiler symlinks as `/usr/lib64/ccache`. You can set it up same way as for other described environments by adding a symlink `/usr/lib/ccache`:

```
;; ln -s ../lib64/ccache/ "$ALTRoot"/usr/lib/
```

Note

For Jenkins agents, also need to `yum install java-11-openjdk-headless` (technically, needs at least JRE 8+).

K.2.3 FreeBSD 12.2

Note that `PATH` for builds on BSD should include `/usr/local/...`:

```
;; PATH=/usr/local/libexec/ccache:/usr/local/bin:/usr/bin:$PATH
;; export PATH
```

Note

You may want to reference `ccache` even before all that, as detailed below.

```

;; pkg install \
    git python perl5 curl \
    gmake autoconf automake autotools libltdl libtool \
    valgrind \
    cppcheck \
    pkgconf \
    gcc clang

# NOTE: For python, you may eventually have to specify a variant like this
# (numbers depending on default or additional packages of your distro):
#   ;; pkg install python2 python27
# and/or:
#   ;; pkg install python3 python37
# You can find a list of what is (pre-)installed with:
#   ;; pkg info | grep -Ei 'perl|python'

# For spell-checking, highly recommended if you would propose pull requests:
;; pkg install \
    aspell en-aspell

# For other doc types (man-page, PDF, HTML) generation - massive packages (TEX, X11):
;; pkg install \
    asciidoc source-highlight textproc/py-pygments dblatex

# For CGI graph generation - massive packages (X11):
;; pkg install \
    libgd

;; pkg install \
    cppunit \
    openssl nss \
    augeas \
    libmodbus \
    neon \
    net-snmp \
    powerman \
    freeipmi \
    avahi

;; pkg install \
    lua51

;; pkg install \
    bash dash busybox ksh93

```

Recommended:

```

;; pkg install ccache
;; ccache-update-links

```

For compatibility with common setups on other operating systems, can symlink `/usr/local/libexec/ccache` as `/usr/lib/ccache` and possibly add dash-number suffixed symlinks to compiler tools (e.g. `gcc-10` beside `gcc10` installed by package).

Note

For Jenkins agents, also need to `pkg install openjdk8` (or 11+)—and do note its further OS configuration suggestions for special filesystem mounts.

Due to BSD specific paths **when not using** an implementation of `pkg-config` or `pkgconf` (so guessing of flags is left to administrator—TBD in NUT `m4` scripts), better use this routine to test the config/build:

```

;; ./configure --with-doc=all --with-all --with-cgi \
  --without-avahi --without-powerman --without-modbus \
  ### CPPFLAGS="-I/usr/local/include -I/usr/include" \
  ### LDFLAGS="-L/usr/local/lib -L/usr/lib"

```

Note the lack of `pkg-config` also precludes `libcppunit` tests, although they also tend to mis-compile/mis-link with GCC (while CLANG seems okay).

K.2.4 OpenBSD 6.4

Note that `PATH` for builds on BSD should include `/usr/local/...`:

```

;; PATH=/bin:/sbin:/usr/bin:/usr/sbin:/usr/local/bin:/usr/local/sbin:$PATH
;; export PATH

```

Note

You may want to reference `ccache` even before all that, as detailed below.

OpenBSD delivers many versions of numerous packages, you should specify your pick interactively or as part of package name (e.g. `autoconf-2.69p2`).

During builds, you may have to tell system dispatcher scripts which version to use (which feels inconvenient, but on the up-side for CI—this system allows to test many versions of auto-tools in the same agent), e.g.:

```

;; export AUTOCONF_VERSION=2.69 AUTOMAKE_VERSION=1.10

```

To use the `ci_build.sh` don't forget `bash` which is not part of OpenBSD base installation. It is not required for "legacy" builds arranged by just `autogen.sh` and `configure` scripts.

Note

The OpenBSD 6.4 `install64.iso` installation includes a set of packages that seems to exceed whatever is available on network mirrors; for example, the CD image included `clang` program while it is not available to `pkg_add`, at least not via <http://ftp.netbsd.hu/mirrors/openbsd/6.4/packages/amd64/> mirror. The `gcc` version on CD image differed notably from that in the networked repository (4.2.x vs 4.9.x)

```

;; pkg_add \
  git python curl \
  gmake autoconf automake libltdl libtool \
  valgrind \
  cppcheck \
  pkgconf \
  gcc clang

# NOTE: For python, you may eventually have to specify a variant like this
# (numbers depending on default or additional packages of your distro):
#   ;; yum install python-2.7.15p0
# and/or:
#   ;; yum install python-3.6.6p1
# although you might succeed specifying shorter names and the packager
# will offer a list of matching variants.
# NOTE: "perl" is not currently a package, but seemingly part of base OS.
# You can find a list of what is (pre-)installed with:
#   ;; pkg_info | grep -Ei 'perl|python'

```

```
# For spell-checking, highly recommended if you would propose pull requests:
;; pkg_add \
    aspell

# For other doc types (man-page, PDF, HTML) generation - massive packages (TEX, X11):
;; pkg_add \
    asciidoc source-highlight py-pygments dblatex \
    docbook2x docbook-to-man

# For CGI graph generation - massive packages (X11):
;; pkg_add \
    gd

;; pkg_add \
    cppunit \
    openssl nss \
    augeas \
    libusb1 \
    neon \
    net-snmp \
    avahi

# Select a LUA-5.1 (or possibly 5.2?) version
;; pkg_add \
    lua

;; pkg_add \
    bash dash busybox ksh93
```

Note

With OpenBSD 6.4, building against freeipmi failed: its libtool recipes referenced `-largp` which did not get installed in the system. Maybe some more packages are needed explicitly?

```
;; pkg_add \
    freeipmi
```

Recommended:

```
;; pkg_add ccache
;; ( mkdir -p /usr/lib/ccache && cd /usr/lib/ccache && \
    for TOOL in cpp gcc g++ clang clang++ clang-cpp ; do \
        ln -s ../../local/bin/ccache "$TOOL" ; \
        done ; \
    )
```

For compatibility with common setups on other operating systems, can add dash-number suffixed symlinks to compiler tools (e.g. `gcc-4.2.1` beside `gcc` installed by package) into `/usr/lib/ccache`.

Note

For Jenkins agents, also need to `pkg_add jre` or `pkg_add jdk` (pick version 1.8 or 8, or 11+).

Due to BSD specific paths **when not using** an implementation of `pkg-config` or `pkgconf` (so guessing of flags is left to administrator—TBD in NUT m4 scripts), better use this routine to test the config/build:

```
;; ./configure --with-doc=all --with-all --with-cgi \
    --without-avahi --without-powerman --without-modbus \
    ### CPPFLAGS="-I/usr/local/include -I/usr/include"
    ### LDFLAGS="-L/usr/local/lib -L/usr/lib"
```

Note the lack of `pkg-config` also precludes `libcppunit` tests, although they also tend to mis-compile/mis-link with GCC (while CLANG seems okay).

K.2.5 NetBSD 9.2

Instructions below assume that `pkgin` tool (`pkg-src` component to "install binary packages") is present on the system. Text below was prepared with a VM where "everything" was installed from the ISO image, including compilers and X11. It is possible that some packages provided this way differ from those served by `pkgin`, or on the contrary, that the list of suggested tool installation below would not include something a bare-minimum system would require to build NUT.

Note that `PATH` for builds on NetBSD should include `local` and `pkg`; the default after installation of the test system was:

```
;; PATH="/sbin:/usr/sbin:/bin:/usr/bin:/usr/pkg/sbin:/usr/pkg/bin:/usr/X11R7/bin:/usr/local ←
  /sbin:/usr/local/bin"
;; export PATH
```

Note

You may want to reference `ccache` even before all that, as detailed below:

```
;; PATH="/usr/lib/ccache:$PATH"
;; export PATH
```

To use the `ci_build.sh` don't forget `bash` which is not part of OpenBSD base installation. It is not required for "legacy" builds arranged by just `autogen.sh` and `configure` scripts.

```
;; pkgin install \
  git python27 python39 perl curl \
  make gmake autoconf automake libltdl libtool \
  cppcheck \
  pkgconf \
  gcc7 clang

;; ( cd /usr/pkg/bin && ( ln -fs python2.7 python2 ; ln -fs python3.9 python3 ) )
# You can find a list of what is (pre-)installed with:
#   ;; pkgin list | grep -Ei 'perl|python'

# For spell-checking, highly recommended if you would propose pull requests:
;; pkgin install \
  aspell aspell-en

# For man-page doc types, footprint on this platform is moderate:
;; pkgin install \
  asciidoc

# For other doc types (PDF, HTML) generation - massive packages (TEX, X11):
;; pkgin install \
  source-highlight py39-pygments dblatex

# For CGI graph generation - massive packages (X11):
;; pkgin install \
  gd openmp

;; pkgin install \
  cppunit \
  openssl nss \
  augeas \
  libusb libusb1 \
  neon \
```

```

net-snmp \
avahi

# Select a LUA-5.1 (or possibly 5.2?) version
;; pkgin install \
lua51

;; pkgin install \
bash dash ast-ksh oksh

```

Note

(TBD) On NetBSD 9.2 this package complains that it requires OS ABI 9.0, or that `CHECK_OSABI=no` is set in `pkg_install.conf`. Such file was not found in the test system...

```

;; pkgin install \
openipmi

```

Recommended: For compatibility with common setups on other operating systems, can add dash-number suffixed symlinks to compiler tools (e.g. `gcc-7` beside the `gcc` installed by package) near the original binaries and into `/usr/lib/ccache`:

```

;; ( cd /usr/bin && for TOOL in cpp gcc g++ ; do \
ln -s "$TOOL" "$TOOL-7" ; \
done )

# Note that the one delivered binary is `clang-13` and many (unnumbered)
# symlinks to it. For NUT CI style of support for builds with many
# compilers, complete the known numbers:
;; ( cd /usr/pkg/bin && for TOOL in clang-cpp clang++ ; do \
ln -s clang-13 "$TOOL-13" ; \
done )

;; pkgin install ccache
;; ( mkdir -p /usr/lib/ccache && cd /usr/lib/ccache && \
for TOOL in cpp gcc g++ clang ; do \
for VER in "" "-7" ; do \
ln -s ../../pkg/bin/ccache "$TOOL$VER" ; \
done ; \
done ; \
for TOOL in clang clang++ clang-cpp ; do \
for VER in "" "-13" ; do \
ln -s ../../pkg/bin/ccache "$TOOL$VER" ; \
done ; \
done ; \
)

```

Note

For Jenkins agents, also need to `pkgin install openjdk11` (will be in `JAVA_HOME=/usr/pkg/java/openjdk11`).

K.2.6 OpenIndiana 2021.10

Note that due to IPS and `pkg(5)`, a version of python is part of baseline illumos-based OS; this may not be the case on some other illumos distributions which do not use IPS however. Currently they use python 3.7 or newer.

To build older NUT releases (2.7.4 and before), you may need to explicitly `pkg install python-27`.

Typical tooling would include:

```
;; pkg install \  
    git curl wget \  
    gnu-make autoconf automake libltdl libtool \  
    valgrind \  
    pkg-config \  
    gnu-binutils developer/linker  
  
# NOTE: For python, some suitable version should be available since `pkg(5)`  
# tool is written in it. Similarly, many system tools are written in perl  
# so some version should be installed. You may specify additional variants  
# like this (numbers depending on default or additional packages of your  
# distro; recommended to group `pkg` calls with many packages at once to  
# save processing time for calculating a build strategy):  
#     ;; pkg install runtime/python-27  
# and/or:  
#     ;; pkg install runtime/python-37 runtime/python-35 runtime/python-39  
# Similarly for perl variants, e.g.:  
#     ;; pkg install runtime/perl-522 runtime/perl-524 runtime/perl-534  
# You can find a list of what is available in remote repositories with:  
#     ;; pkg info -r | grep -Ei 'perl|python'  
  
# For spell-checking, highly recommended if you would propose pull requests:  
;; pkg install \  
    aspell text/aspell/en  
  
# For other doc types (man-page, PDF, HTML) generation - massive packages (TEX, X11):  
;; pkg install \  
    asciidoc libxslt \  
    docbook/dtds docbook/dsssl docbook/xsl docbook docbook/sgml-common pygments-39 \  
    graphviz expect graphviz-tcl  
  
# For CGI graph generation - massive packages (X11):  
;; pkg install \  
    gd  
  
;; pkg install \  
    openssl library/mozilla-nss \  
    library/augeas python/augeas \  
    libusb-1 libusbgen system/library/usb/libusb system/header/header-usb driver/usb/ugen ←  
    \  
    libmodbus \  
    neon \  
    net-snmp \  
    powerman \  
    freeipmi \  
    avahi  
  
;; pkg install \  
    lua  
  
;; pkg install \  
    dash bash shell/ksh93  
  
### Maybe  
;; pkg install \  
    gnu-coreutils  
  
### Maybe - after it gets fixed for GCC builds/linkage  
;; pkg install \  
    cppunit
```

For extra compiler coverage, we can install a large selection of versions, although to meet NUT CI farm expectations we also need to expose "numbered" filenames, as automated below:

```

;; pkg install \
   gcc-48 gcc-49 gcc-5 gcc-6 gcc-7 gcc-9 gcc-10 gcc-11 \
   clang-80 clang-90 \
   ccache

# As of this writing, clang-13 refused to link (claiming issues with
# --fuse-ld which was never specified) on OI; maybe later it will:
;; pkg install \
   developer/clang-13 runtime/clang-13

# Get clang-cpp-X visible in standard PATH (for CI to reference the right one),
# and make sure other frontends are exposed with versions (not all OI distro
# releases have such symlinks packaged right), e.g.:
;; (cd /usr/bin && for X in 8 9 13 ; do for T in "" "++" "-cpp"; do \
   ln -fs "../clang/$X.0/bin/clang$T" "clang${T}-${X}" ; \
done; done)

# If /usr/lib/ccache/ symlinks to compilers do not appear after package
# installation, or if you had to add links like above, call the service:
;; svcadm restart ccache-update-symlinks

```

We can even include a `gcc-4.4.4-ill` version (used to build the illumos OS ecosystems, at least until recently, which is a viable example of an old GCC baseline); but note that so far it conflicts with `libgd` builds at `./configure --with-cgi` stage (its binaries require newer ecosystem):

```

;; pkg install \
   illumos-gcc@4.4.4

# Make it visible in standard PATH
;; (cd /usr/bin && for T in gcc g++ cpp ; do \
   ln -s ../../opt/gcc/4.4.4/bin/$T $T-4.4.4 ; \
done)

# If /usr/lib/ccache/ symlinks to these do not appear, call the service:
;; svcadm restart ccache-update-symlinks

```

OI currently also does not build `cppunit`-based tests well, at least not with GCC (they segfault at run-time with `ostream` issues); a CLANG build works for that however.

It also lacks out-of-the-box Tex suite and `dblatex` in particular, which `asciidoc` needs to build PDF documents. It may be possible to add these from third-party repositories (e.g. SFE) and/or build from sources.

No pre-packaged `cppcheck` was found, either.

Note

For Jenkins agents, also need to `pkg install developer/java/openjdk8` (or `pkg install runtime/java/openjdk11` for JRE 11 — currently the OS does not offer in-distro JDK version 11+).

K.2.7 OmniOS CE (as of release 151036)

Being a minimal-footprint system, OmniOS CE provides very few packages out of the box. There are additional repositories supported by the project, as well as third-party repositories such as SFE. For some dependencies, it may happen that you would need to roll and install your own builds in accordance with that project's design goals.

Note you may need not just the "Core" IPS package publisher, but also the "Extra" one. See OmniOS CE web site for setup details.

```

;; pkg install \
    developer/build/autoconf developer/build/automake developer/build/libtool \
    build-essential ccache git developer/pkg-config \
    runtime/perl \
    asciidoc \
    libgd

;; pkg install \
    net-snmp

# NOTE: For python, some suitable version should be available since `pkg(5)`
# tool is written in it. You may specify an additional variant like this
# (numbers depending on default or additional packages of your distro):
#   ;; pkg install runtime/python-37
# You can find a list of what is available in remote repositories with:
#   ;; pkg info -r | grep -Ei 'perl|python'

```

OmniOS lacks a pre-packaged libusb, however the binary build from contemporary OpenIndiana can be used (copy the header files and the library+symlinks for all architectures you would need).

You may need to set up ccache with the same `/usr/lib/ccache` dir used in other OS recipes. Assuming your Build Essentials pulled GCC 9 version, and ccache is under `/opt/ooce` namespace, that would be like:

```

;; mkdir -p /usr/lib/ccache
;; cd /usr/lib/ccache
;; ln -fs ../../../../opt/ooce/bin/ccache gcc
;; ln -fs ../../../../opt/ooce/bin/ccache g++
;; ln -fs ../../../../opt/ooce/bin/ccache gcpp
;; ln -fs ../../../../opt/ooce/bin/ccache gcc-9
;; ln -fs ../../../../opt/ooce/bin/ccache g++-9
;; ln -fs ../../../../opt/ooce/bin/ccache gcpp-9

```

Given that many of the dependencies can get installed into that namespace, you may have to specify where `pkg-config` will look for them (note that library and binary paths can be architecture bitness-dependent):

```

;; ./configure PKG_CONFIG_PATH="/opt/ooce/lib/amd64/pkgconfig" --with-cgi

```

Note also that the minimal footprint nature of OmniOS CE precludes building any large scope easily, so avoid docs and "all drivers" unless you provide whatever they need to happen.

L CI Farm configuration notes

Note

This chapter contains information about NUT CI farm setup tricks that were applied at different times by the maintainer team to ensure regular builds and tests of the codebase. Whether these are used in daily production today or not, similar setup should be possible locally on developer and contributor machines.

L.1 Setting up the multi-arch Linux LXC container farm for NUT CI

Two NUT websites

This version of the page reflects NUT release `v2.8.0` with codebase committed `ff16dabca` at `2022-04-04T11:04:28+00:00`. Options, features and capabilities in current development (and future releases) are detailed on the main site and may differ from ones described here.

Due to some historical reasons including earlier personal experience, the Linux container setup implemented as described below was done with persistent LXC containers wrapped by LIBVIRT for management. There was no particular use-case for systems like Docker (and no firepower for a Kubernetes cluster) in that the build environment intended for testing non-regression against a certain release does not need to be regularly updated—its purpose is to be stale and represent what users still running that system for whatever reason (e.g. embedded, IoT, corporate) have in their environments.

L.1.1 Common preparations

- Prepare LXC and LIBVIRT-LXC integration, including an "independent" (aka "masqueraded") bridge for NAT, following <https://wiki.debian.org/LXC> and <https://wiki.debian.org/LXC/SimpleBridge>
 - For dnsmasq integration on the independent bridge (lxcbr0 following the documentation examples), be sure to mention:
 - * `LXC_DHCP_CONFILE="/etc/lxc/dnsmasq.conf"` in `/etc/default/lxc-net`
 - * `dhcp-hostsfile=/etc/lxc/dnsmasq-hosts.conf` in/as the content of `/etc/lxc/dnsmasq.conf`
 - * `touch /etc/lxc/dnsmasq-hosts.conf` which would list simple name, IP pairs, one per line (so one per container)
 - * `systemctl restart lxc-net` to apply config (is this needed after setup of containers too, to apply new items before booting them?)
- Install `qemu` with its `/usr/bin/qemu-*-static` and registration in `/var/lib/binfmt`
- Prepare an LVM partition (or preferably some other tech like ZFS) as `/srv/libvirt` and create a `/srv/libvirt/rootfs` to hold the containers
- Prepare `/home/abuild` on the host system (preferably in ZFS with lightweight compression like lz4— and optionally, only if the amount of available system RAM permits, with deduplication; otherwise avoid it); account user and group ID numbers are 399 as on the rest of the CI farm (historically, inherited from OBS workers)
 - It may help to generate an ssh key without a passphrase for `abuild` that it would trust, to sub-login from CI agent sessions into the container. Then again, it may be not required if CI logs into the host by SSH using `authorized_keys` and an SSH Agent, and the inner ssh client would forward that auth channel to the original agent.

```
abuild$ ssh-keygen
# accept defaults

abuild$ cat ~/.ssh/id_rsa.pub >> ~/.ssh/authorized_keys
abuild$ chmod 640 ~/.ssh/authorized_keys
```

- Edit the root (or whoever manages libvirt) `~/.profile` to default the `virsh` provider with:

```
LIBVIRT_DEFAULT_URI=lxc:///system
export LIBVIRT_DEFAULT_URI
```

- If host root filesystem is small, relocate the LXC download cache to the (larger) `/srv/libvirt` partition:

```
;; mkdir -p /srv/libvirt/cache-lxc
;; rm -rf /var/cache/lxc
;; ln -sfr /srv/libvirt/cache-lxc /var/cache/lxc
```

- Maybe similarly relocate shared `/home/abuild` to reduce strain on `rootfs`?

L.1.2 Setup a container

Note that completeness of `qemu` CPU emulation varies, so not all distros can be installed, e.g. "s390x" failed for both `debian10` and `debian11` to set up the `openssh-server` package, or once even to run `/bin/true` (seems to have installed an older release though, to match the outdated emulation?)

While the `lxc-create` tool does not really specify the error cause and deletes the directories after failure, it shows the pathname where it writes the log (also deleted). Before re-trying the container creation, this file can be watched with e.g. `tail -F /var/cache/lxc/.../debootstrap.log`

Note

You can find the list of LXC "template" definitions on your system by looking at the contents of the `/usr/share/lxc/templates/` directory, e.g. a script named `lxc-debian` for the "debian" template. You can see further options for each "template" by invoking its help action, e.g.:

```
;; lxc-create -t debian -h
```

- Install containers like this:

```
;; lxc-create -P /srv/libvirt/rootfs \
  -n jenkins-debian11-mips64el -t debian -- \
  -r bullseye -a mips64el
```

- to specify a particular mirror (not everyone hosts everything — so if you get something like "E: Invalid Release file, no entry for main/binary-mips/Packages" then see <https://www.debian.org/mirror/list> for details, and double-check the chosen site to verify if the distro version of choice is hosted with your arch of choice):

```
;; MIRROR="http://ftp.br.debian.org/debian/" \
  lxc-create -P /srv/libvirt/rootfs \
  -n jenkins-debian10-mips -t debian -- \
  -r buster -a mips
```

- ... or for EOLed distros, use the archive, e.g.:

```
;; MIRROR="http://archive.debian.org/debian-archive/debian/" \
  lxc-create -P /srv/libvirt/rootfs \
  -n jenkins-debian8-s390x -t debian -- \
  -r jessie -a s390x
```

- ... Alternatively, other distributions can be used (as supported by your LXC scripts, typically in `/usr/share/debootstrap/` e.g. Ubuntu:

```
;; lxc-create -P /srv/libvirt/rootfs \
  -n jenkins-ubuntu1804-s390x -t ubuntu -- \
  -r bionic -a s390x
```

- For distributions with a different packaging mechanism from that on the LXC host system, you may need to install corresponding tools (e.g. `yum4`, `rpm` and `dnf` on Debian hosts for installing CentOS and related guests). You may also need to pepper with symlinks to taste (e.g. `yum => yum4`), or find a `pacman` build to install Arch Linux or derivative, etc. Otherwise, you risk seeing something like this:

```
root@debian:~# lxc-create -P /srv/libvirt/rootfs \
  -n jenkins-centos7-x86-64 -t centos -- \
  -R 7 -a x86_64

Host CPE ID from /etc/os-release:
'yum' command is missing
lxc-create: jenkins-centos7-x86-64: lxccontainer.c:
  create_run_template: 1616 Failed to create container from template
lxc-create: jenkins-centos7-x86-64: tools/lxc_create.c:
  main: 319 Failed to create container jenkins-centos7-x86-64
```

Note also that with such "third-party" distributions you may face other issues; for example, the CentOS helper did not generate some fields in the `config` file that were needed for conversion into libvirt "domxml" (as found by trial and error, and comparison to other `config` files):

```
lxc.uts.name = jenkins-centos7-x86-64
lxc.arch = x86_64
```

Also note the container/system naming without underscore in "x86_64" — the deployed system discards the character when assigning its hostname. Using "amd64" is another reasonable choice here.

- Add the "name,IP" line for this container to `/etc/lxc/dnsmasq-hosts.conf` on the host, e.g.:

```
jenkins-debian11-mips,10.0.3.245
```

Note

Don't forget to eventually `systemctl restart lxc-net` to apply the new host reservation!

- Convert a pure LXC container to be managed by LIBVIRT-LXC (and edit config markup on the fly — e.g. fix the LXC `dir:` URL schema):

```
;; virsh -c lxc:///system domxml-from-native lxc-tools \
  /srv/libvirt/rootfs/jenkins-debian11-armhf/config \
  | sed -e 's,dir:/srv,/srv,' \
  > /tmp/x && virsh define /tmp/x
```

Note

You may want to tune the default generic 64MB RAM allocation, so your launched QEMU containers are not OOM-killed as they exceeded their memory `cgroup` limit. In practice they do not eat **that much** resident memory, just want to have it addressable by VMM, I guess (swap is not very used either), at least not until active builds start (and then it depends on compiler appetite and `make` program parallelism level you allow, e.g. by pre-exporting `MAXPARMAKES` environment variable for `ci_build.sh`, and on the number of Jenkins "executors" assigned to the build agent).

- It may be needed to revert the generated "os/arch" to `x86_64` (and let QEMU handle the rest) in the `/tmp/x` file, and re-try the definition:

```
;; virsh define /tmp/x
```

- Then execute `virsh edit jenkins-debian11-armhf` (and same for other containers) to bind-mount the common `/home/abuild` location, adding this tag to their "devices":

```
<filesystem type='mount' accessmode='passthrough'>
  <source dir='/home/abuild'/>
  <target dir='/home/abuild'/>
</filesystem>
```

- Note that generated XML might not conform to current LXC schema, so it fails validation during save; this can be bypassed with `i` when it asks. One such case was however with indeed invalid contents, the "dir:" schema removed by example above.

L.1.3 Shepherd the herd

- Monitor deployed container rootfs'es with:

```
;; du -ks /srv/libvirt/rootfs/*
```

(should have non-trivial size for deployments without fatal infant errors)

- Mass-edit/review libvirt configurations with:

```
;; virsh list --all | awk '{print $2}' \
  | grep jenkins | while read X ; do \
  virsh edit --skip-validate $X ; done
```

– ...or avoid `--skip-validate` when markup is initially good :)

- Mass-define network interfaces:

```
;; virsh list --all | awk '{print $2}' \
| grep jenkins | while read X ; do \
    virsh dumpxml "$X" | grep "bridge='lxcbr0'" \
    || virsh attach-interface --domain "$X" --config \
        --type bridge --source lxcbr0 ; \
done
```

- Verify that unique MAC addresses were defined (e.g. `00:16:3e:00:00:01` tends to pop up often, while `52:54:00:xx:xx:xx` are assigned to other containers); edit the domain definitions to randomize, if needed:

```
;; grep 'mac add' /etc/libvirt/lxc/*.xml | awk '{print $NF " "$1}' | sort
```

- Make sure at least one console device exists (end of file, under the network interface definition tags), e.g.:

```
<console type='pty'>
  <target type='lxc' port='0' />
</console>
```

- Populate with `abuuild` account, as well as with the `bash` shell and `sudo` ability, reporting of assigned IP addresses on the console, and SSH server access complete with `envvar` passing from CI clients by virtue of `ssh -o SendEnv='*' container-name:`

```
;; for ALTROOT in /srv/libvirt/rootfs/*/rootfs/ ; do \
    echo "=== $ALTROOT : " >&2 ; \
    grep eth0 "$ALTROOT/etc/issue" || ( printf '%s %s\n' \
        '\S{NAME} \S{VERSION_ID} \n \l@\b ;' \
        'Current IP(s): \4{eth0} \4{eth1} \4{eth2} \4{eth3}' \
        >> "$ALTROOT/etc/issue" ) ; \
    grep eth0 "$ALTROOT/etc/issue.net" || ( printf '%s %s\n' \
        '\S{NAME} \S{VERSION_ID} \n \l@\b ;' \
        'Current IP(s): \4{eth0} \4{eth1} \4{eth2} \4{eth3}' \
        >> "$ALTROOT/etc/issue.net" ) ; \
    groupadd -R "$ALTROOT" -g 399 abuuild ; \
    useradd -R "$ALTROOT" -u 399 -g abuuild -M -N -s /bin/bash abuuild \
    || useradd -R "$ALTROOT" -u 399 -g 399 -M -N -s /bin/bash abuuild \
    || { if ! grep -w abuuild "$ALTROOT/etc/passwd" ; then \
        echo 'abuuild:x:399:399::/home/abuuild:/bin/bash' \
        >> "$ALTROOT/etc/passwd" ; \
        echo "USERADDED manually: passwd" >&2 ; \
        fi ; \
        if ! grep -w abuuild "$ALTROOT/etc/shadow" ; then \
        echo 'abuuild:!:18889:0:99999:7:::' >> "$ALTROOT/etc/shadow" ; \
        echo "USERADDED manually: shadow" >&2 ; \
        fi ; \
    } ; \
    if [ -s "$ALTROOT/etc/ssh/sshd_config" ]; then \
        grep 'AcceptEnv \*' "$ALTROOT/etc/ssh/sshd_config" || ( \
            ( echo "" ; \
                echo "# For CI: Allow passing any envvars:" ; \
                echo 'AcceptEnv *' ) \
            >> "$ALTROOT/etc/ssh/sshd_config" \
        ) ; \
        fi ; \
done
```

Note that for some reason, in some of those other-arch distros `useradd` fails to find the group anyway; then we have to "manually" add them.

- Let the host know and resolve the names/IPs of containers you assigned:

```
;; grep -v '#' /etc/lxc/dnsmasq-hosts.conf \
| while IFS=, read N I ; do \
  getent hosts "$N" >&2 || echo "$I $N" ; \
done >> /etc/hosts
```

L.1.4 Further setup of the containers

See `NUT docs/config-prereqs.txt` about dependency package installation for Debian-based Linux systems.

It may be wise to not install e.g. documentation generation tools (or at least not the full set for HTML/PDF generation) in each environment, in order to conserve space and run-time stress.

Still, if there are significant version outliers (such as using an older distribution due to vCPU requirements), it can be installed fully just to ensure non-regression—e.g. that when adapting `Makefile` rule definitions or compiler arguments to modern toolkits, we do not lose the ability to build with older ones.

For this, `chroot` from the host system can be used, e.g. to improve the interactive usability for a population of Debian(-compatible) containers (and to use its networking, while the operating environment in containers may be not yet configured or still struggling to access the Internet):

```
;; for ALTRoot in /srv/libvirt/rootfs/*/rootfs/ ; do \
  echo "=== $ALTRoot :" ; \
  chroot "$ALTRoot" apt-get install \
    sudo bash vim mc p7zip p7zip-full pigz pbzip2 git \
; done
```

Similarly for `yum`-managed systems (CentOS and relatives), though specific package names can differ, and additional package repositories may need to be enabled first (see `config-prereqs.txt` for more details such as recommended package names).

Note that technically `(sudo) chroot ...` can also be used from the CI worker account on the host system to build in the prepared filesystems without the overhead of running containers as complete operating environments with any standard services and several copies of Jenkins `agent.jar` in them.

Also note that externally-driven set-up of some packages, including the `ca-certificates` and the `JDK/JRE`, require that the `/proc` filesystem is usable in the `chroot` environment. This can be achieved with e.g.:

```
;; for ALTRoot in /srv/libvirt/rootfs/*/rootfs/ ; do \
  for D in proc ; do \
    echo "=== $ALTRoot/$D :" ; \
    mkdir -p "$ALTRoot/$D" ; \
    mount -o bind,rw "$D" "$ALTRoot/$D" ; \
  done ; \
done
```

TODO: Test and document a working NAT and firewall setup for this, to allow SSH access to the containers via dedicated TCP ports exposed on the host.

L.1.5 Troubleshooting

- Q: Container won't start, its `virsh console` says something like:

```
Failed to create symlink /sys/fs/cgroup/net_cls: Operation not permitted
```

A: According to https://bugzilla.redhat.com/show_bug.cgi?id=1770763 (skip to the end for summary) this can happen when a newer Linux host system with `cgroupsv2` capabilities runs an older guest distro which only knows about `cgroupsv1`, such as when hosting a CentOS 7 container on a Debian 11 server. ** One workaround is to ensure that the guest `systemd` does not try to "join" host facilities, by setting an explicit empty list for that:

+

```
;; echo 'JoinControllers=' >> "$ALTRoot/etc/systemd/system.conf"
```

- Another approach is to upgrade `systemd` related packages in the guest container. This may require additional "backport" repositories or similar means, possibly maintained not by distribution itself but by other community members, and arguably would logically compromise the idea of non-regression builds in the old environment "as is".
 - Q: Server was set up with ZFS as recommended, and lots of I/O hit the disk even when application writes are negligible
 - A: This was seen on some servers and generally derives from data layout and how ZFS maintains the tree structure of blocks. A small application write (such as a new log line) means a new empty data block allocation, an old block release, and bubble up through the whole metadata tree to complete the transaction (grouped as TXG to flush to disk).
- One solution is to use discardable build workspaces in RAM-backed storage like `/dev/shm` (tmpfs) on Linux, or `/tmp` (swap) on illumos hosting systems, and only use persistent storage for the home directory with `.ccache` and `.gitcache-dynamatrix` directories.
- Another solution is to reduce the frequency of TXG sync from modern default of 5 sec to conservative 30-60 sec. Check how to set the `zfs_txg_timeout` on your platform.

L.2 Connecting Jenkins to the containers

To properly cooperate with the `jenkins-dynamatrix` project driving regular NUT CI builds, each build environment should be exposed as an individual agent with labels describing its capabilities.

L.2.1 Agent Labels

With the `jenkins-dynamatrix`, agent labels are used to calculate a large "slow build" matrix to cover numerous scenarios for what can be tested with the current population of the CI farm, across operating systems, `make`, shell and compiler implementations and versions, and C/C++ language revisions, to name a few common "axes" involved.

Labels for QEMU

Emulated-CPU container builds are CPU-intensive, so for them we define as few capabilities as possible: here CI is more interested in checking how binaries behave on those CPUs, **not** in checking the quality of recipes (distcheck, Make implementations, etc.), shell scripts or documentation, which is more efficient to test on native platforms.

Still, we are interested in results from different compiler suites, so specify at least one version of each.

Note

Currently the NUT `Jenkinsfile-dynamatrix` only looks at various `COMPILER` variants for `qemu-nut-builder` use-cases, disregarding the versions and just using one that the environment defaults to.

The reduced set of labels for QEMU workers looks like:

```
qemu-nut-builder qemu-nut-builder:alldrv
NUT_BUILD_CAPS=drivers:all NUT_BUILD_CAPS=cppunit
OS_FAMILY=linux OS_DISTRO=debian11 GCCVER=10 CLANGVER=11
COMPILER=GCC COMPILER=CLANG
ARCH64=ppc64le ARCH_BITS=64
```

Labels for native builds

For contrast, a "real" build agent's set of labels, depending on presence or known lack of some capabilities, looks something like this:

```
doc-builder nut-builder nut-builder:alldrv
NUT_BUILD_CAPS=docs:man NUT_BUILD_CAPS=docs:all
NUT_BUILD_CAPS=drivers:all NUT_BUILD_CAPS=cppunit=no
OS_FAMILY=bsd OS_DISTRO=freebsd12 GCCVER=10 CLANGVER=10
COMPILER=GCC COMPILER=CLANG
ARCH64=amd64 ARCH_BITS=64
SHELL_PROGS=sh SHELL_PROGS=dash SHELL_PROGS=zsh SHELL_PROGS=bash
SHELL_PROGS=csh SHELL_PROGS=tcsh SHELL_PROGS=busybox
MAKE=make MAKE=gmake
PYTHON=python2.7 PYTHON=python3.8
```

L.2.2 Generic agent attributes

- Name: e.g. ci-debian-altroot--jenkins-debian10-arm64 (note the pattern for "Conflicts With" detailed below)
- Remote root directory: preferably unique per agent, to avoid surprises; e.g.: /home/abuild/jenkins-nut-altroots/jenkins
 - Note it may help that the system home directory itself is shared between co-located containers, so that the `.ccache` or `.gitcache-dynamatrix` are available to all builders with identical contents
 - If RAM permits, the Jenkins Agent working directory may be placed in a temporary filesystem not backed by disk (e.g. `/dev/shm` on modern Linux distributions); roughly estimate 300Mb per executor for NUT builds.
- Usage: "Only build jobs with label expressions matching this node"
- Node properties / Environment variables:
 - `PATH+LOCAL` \Rightarrow `/usr/lib/ccache`

L.2.3 Where to run agent.jar

Depending on circumstances of the container, there are several options available to the NUT CI farm:

- Java can run in the container, efficiently (native CPU, different distro) \Rightarrow the container may be exposed as a standalone host for direct SSH access (usually by NAT, exposing SSH on a dedicated port of the host; or by first connecting the Jenkins controller with the host as an SSH Build Agent, and then calling SSH to the container as a prefix for running the agent; or by using Jenkins Swarm agents), so ultimately the `build-agent.jar` JVM would run in the container. Filesystem for the `abuild` account may be or not be shared with the host.
- Java can not run in the container (crashes on emulated CPU, or is too old in the agent container's distro—currently Jenkins requires JRE 8+, but eventually will require 11+) \Rightarrow the agent would run on the host, and then the host would `ssh` or `chroot` (networking not required, but bind-mount of `/home/abuild` and maybe other paths from host would be needed) called for executing `sh` steps in the container environment. Either way, home directory of the `abuild` account is maintained on the host and shared with the guest environment, user and group IDs should match.
- Java is inefficient in the container (operations like un-stashing the source succeed but take minutes instead of seconds) \Rightarrow either of the above

Using Jenkins SSH Build Agents

This is a typical use-case for tightly integrated build farms under common management, where the Jenkins controller can log by SSH into systems which act as its build agents. It injects and launches the `agent.jar` to execute child processes for the builds, and maintains a tunnel to communicate.

Methods below involving SSH assume that you have configured a password-less key authentication from the host machine to the `abuild` account in each guest build environment container. This can be an `ssh-keygen` result posted into `authorized_keys`, or a trusted key passed by a chain of ssh agents from a Jenkins Credential for connection to the container-hoster into the container. The private SSH key involved may be secured by a pass-phrase, as long as your Jenkins Credential storage knows it too. Note that for the approaches explored below, the containers are not directly exposed for log-in from any external network.

- For passing the agent through an SSH connection from host to container, so that the `agent.jar` runs inside the container environment, configure:

- Launch method: "Agents via SSH"
- Host, Credentials, Port: as suitable for accessing the container-hoster

Note

The container-hoster should have accessed the guest container from the account used for intermediate access, e.g. `abuild`, so that its `.ssh/known_hosts` file would trust the SSH server on the container.

- Prefix Start Agent Command: content depends on the container name, but generally looks like the example below to report some info about the final target platform (and make sure `java` is usable) in the agent's log. Note that it ends with un-closed quote and a space char:

```
ssh jenkins-debian10-amd64 '( java -version & uname -a ; getconf LONG_BIT; getconf ←
WORD_BIT; wait ) &&
```

- Suffix Start Agent Command: a single quote to close the text opened above:

```
'
```

- The other option is to run the `agent.jar` on the host, for all the network and filesystem magic the agent does, and only execute shell steps in the container. The solution relies on overridden `sh` step implementation in the `jenkins-dynamatrix` shared library that uses a magic `CI_WRAP_SH` environment variable to execute a pipe into the container. Such pipes can be `ssh` or `chroot` with appropriate host setup described above.

Note

In case of `ssh` piping, remember that the container's `/etc/ssh/sshd_config` should `AcceptEnv *` and the SSH server should be restarted after such configuration change.

- Launch method: "Agents via SSH"
- Host, Credentials, Port: as suitable for accessing the container-hoster
- Prefix Start Agent Command: content depends on the container name, but generally looks like the example below to report some info about the final target platform (and make sure it is accessible) in the agent's log. Note that it ends with a space char, and that the command here should not normally print anything into `stderr/stdout` (this tends to confuse the Jenkins Remoting protocol):

```
echo PING > /dev/tcp/jenkins-debian11-ppc64el/22 &&
```

- Suffix Start Agent Command: empty

- Node properties / Environment variables:

- `CI_WRAP_SH` ⇒

```
ssh -o SendEnv='*' "jenkins-debian11-ppc64el" /bin/sh -xe
```

Using Jenkins Swarm Agents

This approach allows remote systems to participate in the NUT CI farm by dialing in and so defining an agent. A single contributing system may be running a number of containers or virtual machines set up following the instructions above, and each of those would be a separate build agent.

Such systems should be "dedicated" to contribution in the sense that they should be up and connected for days, and sometimes tasks would land.

Configuration files maintained on the Swarm Agent system dictate which labels or how many executors it would expose, etc. Credentials to access the NUT CI farm Jenkins controller to register as an agent should be arranged with the farm maintainers, and currently involve a GitHub account with Jenkins role assignment for such access, and a token for authentication.

The [jenkins-swarm-nutci](#) repository contains example code from such setup with a back-up server experiment for the NUT CI farm, including auto-start method scripts for Linux systemd and upstart, illumos SMF, and OpenBSD rcctl.

L.2.4 Sequentializing the stress

Running one agent at a time

Another aspect of farm management is that emulation is a slow and intensive operation, so we can not run all agents and execute builds at the same time.

The current solution relies on <https://github.com/jimklimov/conflict-aware-ondemand-retention-strategy-plugin> to allow co-located build agents to "conflict" with each other — when one picks up a job from the queue, it blocks neighbors from starting; when it is done, another may start.

Containers can be configured with "Availability ⇒ On demand", with shorter cycle to switch over faster (the core code sleeps a minute between attempts):

- In demand delay: 0;
- Idle delay: 0 (Jenkins may change it to 1);
- Conflicts with: `^ci-debian-altroot--.*$` assuming that is the pattern for agent definitions in Jenkins — not necessarily linked to hostnames.

Also, the "executors" count should be reduced to the amount of compilers in that system (usually 2) and so avoid extra stress of scheduling too many emulated-CPU builds at once.

Sequentializing the git cache access

As part of the `jenkins-dynamatrix` optional optimizations, the NUT CI recipe invoked via `Jenkinsfile-dynamatrix` maintains persistent git reference repositories that can be used to cache NUT codebase (including the tested commits) and so considerably speed up workspace preparation when running numerous build scenarios on the same agent.

Such `.gitcache-dynamatrix` cache directories are located in the build workspace location (unique for each agent), but on a system with numerous containers these names can be symlinks pointing to a shared location.

To avoid collisions with several executors updating the same cache with new commits, critical access windows are sequentialized with the use of [Lockable Resources plugin](#). On the `jenkins-dynamatrix` side this is facilitated by labels:

```
DYNAMATRIX_UNSTASH_PREFERENCE=scm-ws:nut-ci-src
DYNAMATRIX_REFREPO_WORKSPACE_LOCKNAME=gitcache-dynamatrix:SHARED_HYPERVISOR_NAME
```

- The `DYNAMATRIX_UNSTASH_PREFERENCE` tells the `jenkins-dynamatrix` library code which checkout/unstash strategy to use on a particular build agent (following values defined in the library; `scm-ws` means SCM caching under the agent workspace location, `nut-ci-src` names the cache for this project);
- The `DYNAMATRIX_REFREPO_WORKSPACE_LOCKNAME` specifies a semi-unique string: it should be same for all co-located agents which use the same shared cache location, e.g. guests on the same hypervisor; and it should be different for unrelated cache locations, e.g. different hypervisors and stand-alone machines.